

ESSENTIALS OF CHEMISTRY

SØREN PRIP BEIER & PETER DYBDAHL HEDE



DOWNLOAD FREE TEXT BOOKS AT
BOOKBOON.COM

Søren Prip Beier & Peter Dybdahl Hede

Chemistry

2nd edition

Chemistry – 2nd edition

© 2010 Søren Prip Beier & Peter Dybdahl Hede & Ventus Publishing ApS

ISBN 978-87-7681-535-6

Contents

Preface	8
1. Atoms	9
1.1 Atomic nucleus, electrons, and orbitals	9
1.1.1 Components of the atom	9
1.1.2 Electron movement and electromagnetic radiation	11
1.1.3 Bohr's atomic model	13
1.1.4 Photons	15
1.1.5 Radioactive decay	18
1.1.6 Wave functions and orbitals	21
1.1.7 Orbital configuration	22
1.2 Construction of the periodic table	25
1.2.1 Aufbau principle	25
1.2.2 Electron configuration	26
1.2.3 Categorization of the elements	33
1.2.4 Periodic tendencies	35
1.3 Summing up on chapter 1	41
2. Chemical compounds	42
2.1 Bonds and forces	43
2.1.1 Bond types (intramolecular forces)	43

Please click the advert

WHAT'S MISSING IN THIS EQUATION?

You could be one of our future talents

MAERSK INTERNATIONAL TECHNOLOGY & SCIENCE PROGRAMME

Are you about to graduate as an **engineer** or **geoscientist**? Or have you already graduated?
If so, there may be an exciting future for you with A.P. Moller - Maersk.



MAERSK

www.maersk.com/mitas

2.1.2	Intermolecular forces	44
2.2	Covalent bonds	48
2.2.1	Energy considerations	49
2.2.2	Molecular orbital theory	50
2.2.3	Lewis structure	54
2.2.4	VSEPR theory	64
2.2.5	Orbital hybridization	68
2.3	Metallic bonds	74
2.3.1	Band theory	74
2.3.2	Lattice structures	76
2.4	Ionic bonds	84
2.4.1	Ionic character	84
2.4.2	Lattice structures for ionic compounds	86
2.4.3	Energy calculations for ionic compounds	89
2.5	Summing up on chapter 2	92
3.	Reaction kinetics	93
3.1	Chemical reactions	93
3.2	Reaction rate	94
3.3	Rate expressions	96
3.4	Kinetics and catalysts	97
3.5	Kinetics of radioactive decay	100
3.6	Summing up on chapter 3	103



4.	Chemical equilibrium	104
4.1	Solubility product	104
4.1.1	Relative solubility	105
4.1.2	Ion effects on solubility	107
4.2	Precipitation	109
4.2.1	Selective precipitation	111
4.3	Summing up on chapter 4	112
5.	Acids and bases	113
5.1	About acids and bases	113
5.1.1	Acid strength	113
5.1.2	The pH-scale	114
5.1.3	The autoprotolysis of water	115
5.2	pH calculations	116
5.2.1	Calculation of pH in strong acid solutions	117
5.2.2	Calculation of pH in weak acid solutions	117
5.2.3	Calculation of pH in mixtures of weak acids	119
5.3	Polyprotic acids	121
5.4	Acid properties of salts	123
5.4	Ion effects on pH	125
5.5	Buffer	127
5.5.1	The Buffer equation	127
5.5.2	Buffer capacity	131
5.6	Titrations and pH curves	131

Please click the advert



CHALLENGE YOURSELF

WWW.STUDYINSWEDEN.SE

Si.
Swedish Institute

Today's job market values ambitious, innovative, perceptive team players. Swedish universities foster these qualities through a forward-thinking culture where you're close to the latest ideas and global trends.

Whatever your career goals may be, studying in Sweden will give you valuable skills and a competitive advantage for your future. www.studyinsweden.se

5.6.1	Titration of a polyprotic acids	137
5.6.2	Colour indicators for acid/base titration	140
5.7	Summing up on chapter 5	141
6.	Electrochemistry	142
6.1	Oxidation and reduction	142
6.1.1	Level of oxidation	143
6.1.2	Methods for balancing redox reactions	145
6.2	Galvanic cells	150
6.2.2	Cell potentials	152
6.3	Standard reduction potentials	152
6.4	Concentration dependency of cell potentials	157
6.5	Batteries	162
6.6	Corrosion	169
6.7	Electrolysis	172
6.8	Summing up on chapter 6	174

Please click the advert

Always aiming for higher ground. Just another day at the office for a Tiger.

Join the Accenture High Performance Business Forum

On Thursday, April 23rd, Accenture invites top students to the High Performance Business Forum where you can learn how leading Danish companies are using the current economic downturn to gain competitive advantages. You will meet two of Accenture's global senior executives as they present new original research and illustrate how technology can help forward thinking companies cope with the downturn.

Visit student.accentureforum.dk to see the program and register

Visit student.accentureforum.dk

• Consulting • Technology • Outsourcing

accenture
High performance. Delivered.

© 2009 Accenture. All rights reserved.

Preface

This book is written primarily to engineering students in the fields of basic chemistry, environmental chemistry, food production, chemical and biochemical engineering who in the beginning of their university studies receive education in inorganic chemistry and applied chemistry in general.

The aim of this book is to explain and clarify important terms and concepts which the students are supposed to be familiar with. The book can not replace existing educational textbooks but it gives a great supplement to the education within chemistry. Many smaller assignments and examples including solutions are given in the book.

The book is divided into six chapters covering the introductory parts of the education within chemistry at universities and chemical engineering schools. One of the aims of this book is to lighten the shift from grammar school/high school/gymnasium to the university.

We alone are responsible for any misprints or errors and we will be grateful to receive any critics and suggestions for improvement.

Chapter 1 }
Chapter 2 } Søren Prip Beier

Copenhagen, November 2009

Chapter 3 }
Chapter 4 } Peter Dybdahl Hede
Chapter 5 }
Chapter 6 }

Søren Prip Beier & Peter Dybdahl Hede

1. Atoms

The aim of this chapter is to introduce important concepts and theory within fundamental aspects of chemistry. Initially we are going to look at the single atom itself and then we move to the arrangement of the atoms (elements) into the periodic table.

1.1 Atomic nucleus, electrons, and orbitals

The topic of this first chapter is the single atoms. All matter is composed of atoms and to get a general understanding of the composition of atoms we first have to learn about electromagnetic radiation. Electromagnetic radiation is closely related to the nature of atoms and especially to the positions and movements of the electrons relative to the atomic nuclei.

1.1.1 Components of the atom

An atom is composed of a *nucleus* surrounded by *electrons*. The nucleus consists of positively charged *protons* and uncharged *neutrons*. The charge of an electron is -1 and the charge of a proton is $+1$. An atom in its ground state is neutral (uncharged) because it consists of an equal amount of protons and electrons. The number of neutrons in the nucleus of an element can however vary resulting in more than one *isotope*. Hydrogen for example has three isotopes:

- Hydrogen, H, Nucleus composition : 1 proton + 0 neutrons
 - Deuterium, D, Nucleus composition : 1 proton + 1 neutron
 - Tritium, T, Nucleus composition : 1 proton + 2 neutrons
- } the 3 isotopes of hydrogen

The three isotopes of hydrogen each have its own chemical symbol (H, D, and T) whereas isotopes of other elements do not have special chemical symbols. Many elements have many isotopes but only relatively few of these are stable. A stable isotope will not undergo radioactive decay. The nucleus of an unstable isotope on the other hand will undergo radioactive decay which means that the nucleus will transform into other isotopes or even other elements under emission of radiation. In the following example we will look more at isotopes for the element uranium.

Example 1- A: Two isotopes of uranium

A classical example of an element with unstable isotopes is uranium. Uranium-235 is a uranium isotope in which the nucleus consists of 92 protons and 143 neutrons ($92 + 143 = 235$). *Nucleons* are a common designation for both protons and neutrons since they are both positioned in the nucleus. Uranium-238 is another uranium isotope in which the nucleus consists of 92 protons and 146 neutrons (total number of nucleons = $92 + 146 = 238$). These two uranium isotopes can be written as follows:

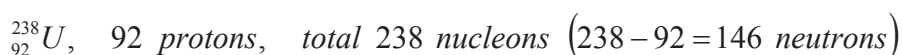

It is seen that the two isotopes do not have special chemical symbols. However, both have a “U” but with the total nucleon and proton number as prefix. The nucleon numbers are not the same.

The nucleus constitutes only a very small part of the total volume of the atom. If an atom is compared with an orange (100 mm in diameter) the nucleus will be placed in the centre with a diameter of only 0.001 mm. The mass of a proton and a neutron is approximately the same (1.67×10^{-27} kg) whereas the mass of an electron is only 0.05% of this mass (9.11×10^{-31} kg). If an atom lets off or receives electrons it becomes an *ion*. An ion is either positively or negatively charged. If an atom lets off one or more electrons the overall charge will become positive and you then have a so-called *cation*. If an atom receives one or more electrons the overall charge will be negative and you have an *anion*.

When electrons are let off or received the *oxidation state* of the atom is changed. We will look more into oxidation states in the following example.

Example 1- B: Oxidation states for single ions and composite ions

When magnesium and chlorine reacts, the magnesium atom lets off electrons to chlorine and thus the oxidation states are changed:



One sees that the oxidation state equals the charge of the ion. The cations are normally named just by adding “ion” after the name of the atom (Mg^+ = magnesium ion) whereas the suffix “-id” replaces the suffix of the atom for anions (Cl^- = chloride). For composite ions, a shared (total) oxidation number is used. This shared oxidation state is the sum of all the oxidation states for the different ions in the composite ion. Uncharged atoms have the oxidation number of zero. The ammonium ion and hydroxide are both examples of composite ions:

NH_4^+ *Oxidation state for ammonium: +1*

OH^- *Oxidation state for hydroxide: -1*

The oxidation state for hydride is always “+1” (H^+) and the oxidation state for oxide is always “-2” (O^{2-}). However there are exceptions. For example the oxidation state of oxygen in hydrogen peroxide (H_2O_2) is “-1” and in lithium hydride (LiH) the oxidation state of hydrogen is “-1”.

1.1.2 Electron movement and electromagnetic radiation

Description of the position of electrons relative to the atomic nucleus is closely related to emission and absorption of electromagnetic radiation. Therefore we are going to look a bit more into this topic. Energy can be transported by electromagnetic radiation as waves. The wavelength can vary from 10^{-12} meter (gamma radiation) to 10^4 meter (AM radio waves). Visible light is also electromagnetic radiation with wavelengths varying from 4×10^{-7} meter (purple light) to 7×10^{-7} meter (red light). Thus visible light only comprises a very small part of the electromagnetic radiation spectrum.

Light with different wavelengths have different colours. White light consists of light with all wavelengths in the visible spectrum. The relationship between wavelength and frequency is given by the following equation:

$$c = \lambda \cdot f, \quad c = 3 \times 10^8 \text{ m/s} \quad (1-1)$$

The speed of light c is a constant whereas λ denotes the wavelength of the radiation and f denotes the frequency of the radiation. When light passes through for example a prism or a raindrop it diffracts. The degree of diffraction is dependent upon the wavelength. The larger the wavelength the less is the diffraction and the smaller the wavelength the larger is the diffraction. When white light (from the sun for example) is sent through a prism or through a raindrop it thus diffracts into a continuous spectrum which contains all visible colours from red to purple (all rainbow colours) which is sketched in Figure 1- 1.

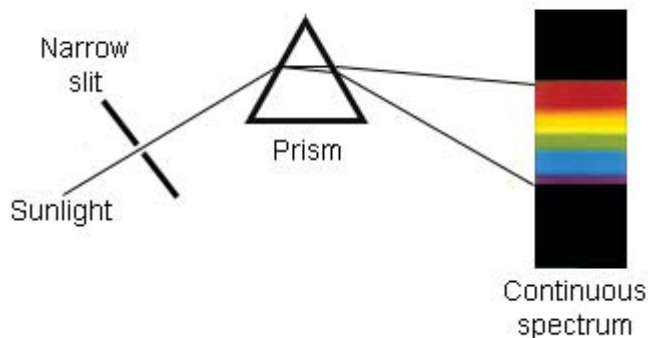

Figure 1- 1: Continuous spectrum.
Diffraction of sun light into a continuous colour spectrum.

When samples of elements are burned, light is emitted, but this light (in contrast to a continuous spectrum) is diffracted into a so-called *line spectrum* when it passes through a prism. Such an example is sketched in Figure 1- 2.

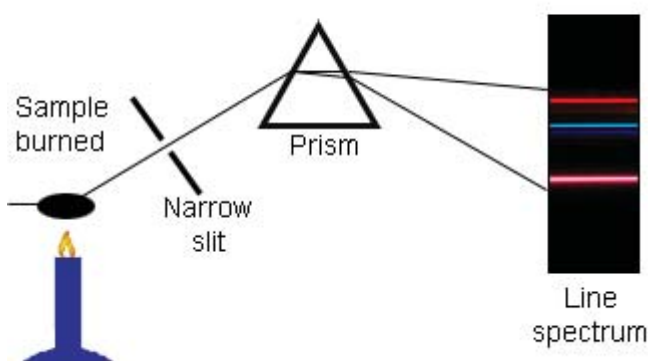

Figure 1- 2: Line spectrum.
Light from a burning sample of an element diffracts into a line spectrum.

Thus only light with certain wavelengths are emitted corresponding to the individual lines in the line spectrum when an element sample is burned. How can that be when light from the sun diffracts into a continuous spectrum? During the years, many scientists have tried to answer this question. The overall answer is that it has got something to do with the positions of the electrons relative to the atomic nucleus. We will try to give a more detailed answer by explaining different relevant theories and models concerning this phenomenon in the following sections.

1.1.3 Bohr's atomic model

Based on the line spectrum of hydrogen, the Danish scientist Niels Bohr tried to explain why hydrogen only emits light with certain wavelengths when it is burned. According to his theory the electrons surrounding the nucleus are only able to move around the nucleus in certain circular orbits. The single orbits correspond to certain energy levels. The orbit closest to the nucleus has the lowest energy level and is allocated with the *primary quantum number* $n = 1$. The next orbit is allocated with the primary quantum number $n = 2$ and so on. When hydrogen is in its *ground state* the electron is located in the inner orbit ($n = 1$). In Figure 1- 3 different situations are sketched. The term “photon” will be explained in the next sub section and for now a photon is just to be considered as an electromagnetic wave.

Please click the advert



it's an **interesting** world

Get under the skin of it.

Graduate opportunities
Cheltenham | £24,945 + benefits

One of the UK's intelligence services, GCHQ's role is two-fold: to gather and analyse intelligence which helps shape Britain's response to global events, and, to provide technical advice for the protection of Government communication and information systems. In doing so, our specialists – in IT, internet, engineering, languages, information assurance, mathematics and intelligence – get well beneath the surface of global affairs. If you thought the world was an interesting place, you really ought to explore our world of work.



www.careersinbritishintelligence.co.uk

Applicants must be British citizens. GCHQ values diversity and welcomes applicants from all sections of the community. We want our workforce to reflect the diversity of our work.

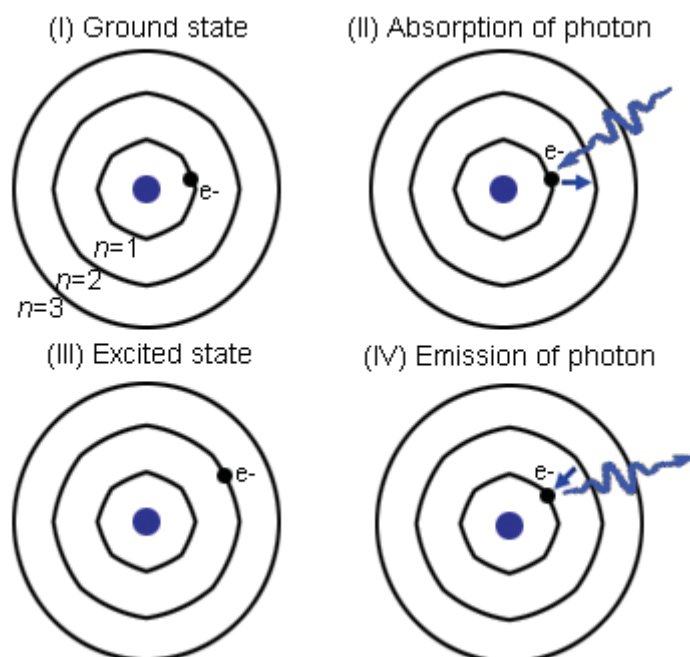

Figure 1- 3: Bohr's atomic model for hydrogen.

Sketch of the hydrogen atom according to Niels Bohr's atomic model. Only the inner three electron orbits are shown. I) The hydrogen atom in its ground state. II) The atom absorbs energy in the form of a photon. The electron is thus supplied with energy so that it can "jump" out in another orbit with higher energy level. III) The hydrogen atom is now in excited state. IV) The electron "jumps" back in the inner lower energy level orbit. Thus the atom is again in ground state. The excess energy is released as a photon. The energy of the photon corresponds to the energy difference between the two inner orbits in this case.

If the atom is supplied with energy (for example by burning) the electron is able to "jump" out in an outer orbit ($n > 1$). Then the atom is said to be in *excited state*. The excited electron can then "jump" back into the inner orbit ($n = 1$). The excess energy corresponding to the energy difference between the two orbits will then be emitted in the form of electromagnetic radiation with a certain wavelength. This is the answer to why only light with certain wavelengths are emitted when hydrogen is burned. The different situations are sketched in Figure 1- 3. Bohr's atomic model could explain the lines in the line spectrum of hydrogen, but the model could not be extended to atoms with more than one electron. Thus the model is considered as being fundamentally wrong. This means that other models concerning the description of the electron positions relative to the nucleus are necessary if the line spectra are to be explained and understood. We are going to look more into such models in the sections *1.1.6 Wave functions and orbitals* and *1.1.7 Orbital configuration*, but first we have to look more into photons.

1.1.4 Photons

In section 1.1.2 *Electron movement and electromagnetic radiation* electromagnetic radiation is described as continuous waves for which the correlation between wavelength and frequency is given by equation (1- 1). With this opinion of electromagnetic radiation, energy portions of arbitrary size are able to be transported by electromagnetic radiation. However, the German physicist Max Planck disproved this statement by doing different experiments. He showed that energy is *quantized* which means that energy *only* can be transported in portions with specific amounts of energy called *quanta*. Albert Einstein further developed the theory of Planck and stated that *all* electromagnetic radiation is quantized. This means that electromagnetic radiation can be considered as a stream of very small “particles” in motion called *photons*. The energy of a photon is given by equation (1- 2) in which h is the Planck’s constant and c is the speed of light.

$$E_{\text{photon}} = h \cdot \frac{c}{\lambda}, \quad h = 6.626 \times 10^{-34} \text{ J} \cdot \text{s}, \quad c = 3 \times 10^8 \text{ m/s} \quad (1-2)$$

It is seen that the smaller the wavelength, the larger the energy of the photon. A photon is not a particle in a conventional sense since it has no mass when it is at rest. Einstein revolutionized the physics by postulating a correlation between mass and energy. These two terms were previously considered as being *totally* independent. On the basis of viewing electromagnetic radiation as a stream of photons, Einstein stated that energy is actually a form of mass and that all mass exhibits both particle and wave characteristics. Very small masses (like photons) exhibit a little bit of particle characteristics but predominantly wave characteristics. On the other hand, large masses (like a thrown ball) exhibit a little bit of wave characteristics but predominantly particle characteristics. These considerations results in this very well known equation:

$$E = m \cdot c^2, \quad c = 3 \times 10^8 \text{ m/s} \quad (1-3)$$

The energy is denoted E and hence the connection postulated by Einstein between energy and mass is seen in this equation. The previous consideration of electromagnetic radiation as continuous waves being able to transport energy with no connection to mass *can* however still find great applications since photons (as mentioned earlier) mostly exhibit wave characteristics and only to a very little extent particle (mass) characteristics. In the following example we will see how we can calculate the energy of a photon.

Example 1- C: Energy of a photon

A lamp emits blue light with a frequency of 6.7×10^{14} Hz. The energy of one photon in the blue light is to be calculated. Since the frequency of the light is known, equation (1- 1) can be used to calculate the wavelength of the blue light:

$$c = \lambda \cdot f \Leftrightarrow \lambda = \frac{c}{f} = \frac{3 \times 10^8 \text{ m/s}}{6.7 \times 10^{14} \text{ s}^{-1}} = 4.5 \times 10^{-7} \text{ m}$$

This wavelength of the blue light is inserted into equation (1- 2):

$$E_{\text{photon}} = h \cdot \frac{c}{\lambda} = 6.626 \times 10^{-34} \text{ J} \cdot \text{s} \cdot \frac{3 \times 10^8 \text{ m/s}}{4.5 \times 10^{-7} \text{ m}} = 4.4 \times 10^{-19} \text{ J}$$

Now we have actually calculated the energy of one of the photons in the blue light that is emitted from the lamp. From equation (1- 2) it is seen that the smaller the wavelength the more energy is contained in the light since the photons each carries more energy.

Please click the advert

CHALLENGE YOURSELF

WWW.STUDYINSWEDEN.SE

Today's job market values ambitious, innovative, perceptive team players. Swedish universities foster these qualities through a forward-thinking culture where you're close to the latest ideas and global trends.

Si.
Swedish Institute

Whatever your career goals may be, studying in Sweden will give you valuable skills and a competitive advantage for your future. www.studyinsweden.se

In the next example we are going to use the Einstein equation (equation (1- 3) to evaluate the stability of a tin nucleus. In the text to follow, the use of the word "favourable" refers to the principle of energy minimization, e.g. it is favourable for two atoms to join into a molecule when the total energy state, by such a reaction, will be lowered.

Example 1- D: Mass and energy (Einstein equation)

From a thermodynamic point of view the stability of an atomic nucleus means that in terms of energy it is favourable for the nucleus to exist as a whole nucleus rather than split into two parts or (hypothetically thinking) exist as individual neutrons and protons. The thermodynamic stability of a nucleus can be calculated as the change in potential energy when individual neutrons and protons join and form a nucleus. As an example we are going to look at the tin isotope tin-118. Tin is element number 50 and thus this isotope contains 50 protons and $118 - 50 = 68$ neutrons in the nucleus. In order to calculate the change in energy when the nucleus is "formed" we first have to determine the change in mass when the following hypothetical reaction occurs:

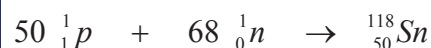

The mass on the right side of this reaction is actually not the same as the mass on the left side. First we will look at the masses and change in mass:

Mass on left side of the reaction:

$$\text{Mass}(50 \text{ } ^1_1\text{p} + 68 \text{ } ^1_0\text{n}) = 50 \cdot 1.67262 \times 10^{-27} \text{ kg} + 68 \cdot 1.67497 \times 10^{-27} \text{ kg} = 1.97526 \times 10^{-25} \text{ kg}$$

Mass on right side of the reaction:

$$\text{Mass}(\text{}^{118}_{50}\text{Sn}) = \frac{117.90160 \times 10^{-3} \text{ kg / mol}}{6.022 \times 10^{23} \text{ mol}^{-1}} = 1.95785 \times 10^{-25} \text{ kg}$$

Change in mass when reaction occurs (tin-118 formation):

$$\text{Mass change} = 1.95785 \times 10^{-25} \text{ kg} - 1.97526 \times 10^{-25} \text{ kg} = -1.74145 \times 10^{-27} \text{ kg}$$

It is thus seen that when the reaction occurs and the tin-118 nucleus is formed, mass "disappears". This change in mass can be inserted into the Einstein equation (equation (1- 3) and the change in potential energy can be calculated.

$$\Delta E = \Delta m \cdot c^2 \Leftrightarrow$$

$$\Delta E = -1.74145 \times 10^{-27} \text{ kg} \cdot (3 \times 10^8 \text{ m/s})^2 = -1.6 \times 10^{-10} \text{ J}$$

It is seen that the “disappeared” mass has been converted into 1.6×10^{-10} Joules which then are released. This corresponds to 980 MeV (1 Mega electron Volt corresponds to 1.60×10^{-13} J). This amount of energy can be translated into an amount of energy pr. nucleon:

$$\Delta E = \frac{-980 \text{ MeV}}{118 \text{ neukleoner}} = -8.3 \text{ MeV / neukleon}$$

Thus it is seen that from a thermodynamic point of view it is favourable for 50 protons and 68 neutrons to join and form a tin-118 nucleus because energy can be released. The numerical value of the energy pr. nucleon is the energy required to break down the tin-118 nucleus into free protons and neutrons. Hence the *binding energy* pr. nucleon in the tin-118 nucleus is 8.3 MeV.

1.1.5 Radioactive decay

When an unstable isotope decays it means that the nucleus changes. When this happens it is because it is more favourable for the nucleus to change from a higher energy level to a lower energy level. Thus energy is released when a nucleus undergoes radioactive decay and the energy is emitted as radiation. Radioactive decay mainly results in one of the three following types of radiation:

- Alpha radiation (α radiation). The radiation consists of helium nuclei (2 neutrons + 2 protons)
- Beta radiation (β radiation). The radiation consists of electrons
- Gamma radiation (γ radiation). The radiation is electromagnetic radiation (photons)

When a nucleus decays and alpha radiation is emitted, the nucleus loses 2 neutrons and 2 protons which correspond to a helium nucleus. When a nucleus decays and beta radiation is emitted, a neutron in the nucleus is transformed into an electron and a proton. The electron will then be emitted as beta radiation. Gamma radiation is electromagnetic radiation which (as mentioned in section

1.1.4 Photons) corresponds to photons. Alpha radiation is often followed by gamma radiation. When a nucleus decays it often happens in a so-called *decay chain*. This means that when a nucleus decays it is transformed into another nucleus which then again can decay into a third nucleus. This happens until a stable nucleus is formed. In the following example we will look at a radioactive decay and emission of radiation.

Example 1- E: Emission of alpha and gamma radiation

The uranium isotope U-238 decays under emission of alpha radiation. Such decay can sometimes be followed by gamma radiation in the form of emission of two photons. The decay can be sketched as follows:



On the left side it is seen that the uranium isotope has 92 protons in the nucleus (corresponding to the element number of 92 for uranium). It is also seen that the uranium isotope has 238 nucleons in total in the nucleus. When an alpha particle (2 neutrons + 2 protons) is emitted the remaining nucleus only contains 90 protons and a total of 234 nucleons. When the number of protons in the nucleus changes it corresponds to that uranium has decayed into another element which in this case is thorium (Th). Thorium has the element number of 90 in the periodic table (the periodic table will be described more in details in later sections).

Alpha radiation can be followed by gamma radiation and in the case of uranium-238 decay, two gamma quanta (photons) can sometimes be emitted. These photons have different energy levels (wavelengths) and can be written as ${}_0^0\gamma$ since the photons has no mass at rest and no charge.

We have now seen an example with emission of alpha and gamma radiation from the decay of uranium-238 into thorium-234. In the next example the emission of beta radiation from the unstable oxygen-20 isotope will be sketched.

Example 1- F: Emission of beta radiation

Oxygen is very well known and the stable oxygen-18 isotope is by far the most occurring oxygen isotope (8 protons and 10 neutrons in the nucleus). The oxygen-20 isotope is however not stable and it decays under emission of beta radiation which can be sketched as follows:

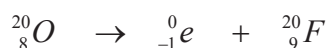

One of the neutrons in the oxygen-20 nucleus is transformed into a proton and an electron. The electron is emitted as beta radiation and because of the “extra” proton, the nucleus is now a fluorine nucleus with a total of 20 nucleons. Thus the oxygen-20 isotope decays into a fluorine-20 isotope. Because the electron is not a nucleon and because its mass is extremely small relative the mass of protons and neutrons, the electron is written as ${}^0_{-1}\text{e}$. The “-1” corresponds to the charge of “-1” of the electron.

It was mentioned earlier that radioactive decay often happens in *decay chains* until at stable nucleus is reached. In the following example such a decay chain will be shown.

Example 1- G: Decay chain

As mentioned earlier radioactive decays often happen in decay chains until a stable isotope is reached. The decay of oxygen-20 can be used as an example of a decay chain:

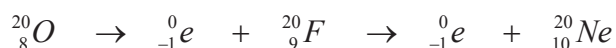

First the unstable oxygen-20 isotope decays into the unstable fluorine-20 isotope under emission of beta radiation. The unstable fluorine-20 isotope then decays into a stable neon-20 isotope under emission of beta radiation. Since the last isotope (neon-20) is stable, the decay chain ends at this point.

A decay chain can also contain a combination of alpha, beta, and gamma radiation and not just beta radiation as in the example above.

1.1.6 Wave functions and orbitals

In the section *1.1.3 Bohr's atomic model* we saw that the atomic model of Niels Bohr could not be applied to atoms with more than one electron. Thus the electrons do not move around the nucleus in circular orbits as proposed by Niels Bohr. In section *1.1.4 Photons* we further saw that there is a connection between energy and mass as proposed by the Albert Einstein equation. This means that electromagnetic radiation can be considered as a stream of very small particles in motion (photons) and that particles in motion can exhibit wave characteristics. Taking that into account, electrons in motion can either be considered as particles or waves. The scientist Erwin Schrödinger used this to derive a mathematical model (*Schrödinger wave function*) describing the probability of finding an electron in a certain location relative to the nucleus:

$$\frac{\partial^2\Psi}{\partial x^2} + \frac{\partial^2\Psi}{\partial y^2} + \frac{\partial^2\Psi}{\partial z^2} + \frac{8\pi^2m}{b^2}(E - V)\Psi = 0 \quad (1-4)$$

This 2nd order differential equation looks quite nasty at first sight. However we do not have to worry about having to solve this equation because it has already been done. Solutions to this equation are the so-called *wave functions* which are denoted with the symbol Ψ . The total energy of the system is denoted E , and V is the potential energy while m is the mass of the electron. The square of the wave function (Ψ^2) is the probability of finding the electron in a certain location relative to the nucleus. There are many solutions to such a 2nd order differential equation and each solution specifies a so-called *orbital*. An orbital is thus a certain “volume” or area relative to the nucleus in which the probability of finding a specific electron is given by the square of the wave function (Ψ^2). Each orbital is assigned with the following three quantum numbers:

- n , primary quantum number. Can have the values 1, 2, 3, ... , ∞ . The primary quantum number tells something about the size and energy level of the orbital. Larger n means larger orbital further away from the nucleus.
- l , angular momentum quantum number. Can have values from 0 to $n-1$. The angular momentum quantum number tells something about the shape of the orbital.
- m_l , magnetic quantum number. Can have values from $-l$ to $+l$. The magnetic quantum number tells something about the orientation of the orbital in space.

Every orbital surrounding a nucleus have a unique set of these three quantum numbers which are all integers. Hence two different orbitals can never have the same combination of these three quantum numbers. In each orbital two electrons can be hosted which leads to the introduction of a fourth quantum number.

- m_s , spin quantum number. Can have the value of either $-\frac{1}{2}$ or $+\frac{1}{2}$

Each of the two electrons in an orbital are thus assigned with the spin quantum number of either $-\frac{1}{2}$ or $\frac{1}{2}$. This means that each electron in an atom is assigned with a total of four quantum numbers. The first three quantum numbers (n , l and m_l) tell which orbital the electron is placed in, while the last quantum number (the spin quantum number m_s) is just introduced in order to give each electron its unique set of quantum numbers. Since two electrons can be hosted in one orbital there is a need for the spin quantum number. The fact that each electron has its own unique set of quantum numbers is called *Pauli's exclusion principle*. If only one electron is hosted in an orbital this electron is said to be unpaired. An atom which has unpaired electrons in one or more orbitals is said to be *paramagnetic*. On the other hand an atom without unpaired electrons is said to be *diamagnetic*.

- *Paramagnetic* atom: An atom that has unpaired electrons in one or more orbitals
- *Diamagnetic* atom: An atom that has *no* unpaired electrons in its orbitals.

1.1.7 Orbital configuration

As mentioned in section 1.1.6 *Wave functions and orbitals* the angular momentum quantum number l determines the shape of the orbital while the magnetic quantum number m_l determines the orientation of the orbital relative to the nucleus. Each orbital is designated with a letter depending on the value of the angular momentum quantum number l :

Please click the advert



Brain power

By 2020, wind could provide one-tenth of our planet's electricity needs. Already today, SKF's innovative know-how is crucial to running a large proportion of the world's wind turbines.

Up to 25 % of the generating costs relate to maintenance. These can be reduced dramatically thanks to our systems for on-line condition monitoring and automatic lubrication. We help make it more economical to create cleaner, cheaper energy out of thin air.

By sharing our experience, expertise, and creativity, industries can boost performance beyond expectations. Therefore we need the best employees who can meet this challenge!

The Power of Knowledge Engineering

Plug into The Power of Knowledge Engineering.
Visit us at www.skf.com/knowledge

SKF

- $l = 0$, orbital is designated with the letter s . $m_l = 0$ (1 orbital)
- $l = 1$ orbital is designated with the letter p . $m_l = -1, 0, +1$ (3 orbitals)
- $l = 2$, orbital is designated with the letter d . $m_l = -2, -1, 0, 1, 2$ (5 orbitals)
- $l = 3$, orbital is designated with the letter f . $m_l = -3, -2, -1, 0, 1, 2, 3$ (7 orbitals)

Although the angular momentum quantum number l can attain larger values than “3” (there should thus be more than the four orbital types; s , p , d , and f) it is only in those four mentioned types of orbital that electrons are hosted. In Figure 1- 4 sketches of the s -, p - and d -orbitals are shown.

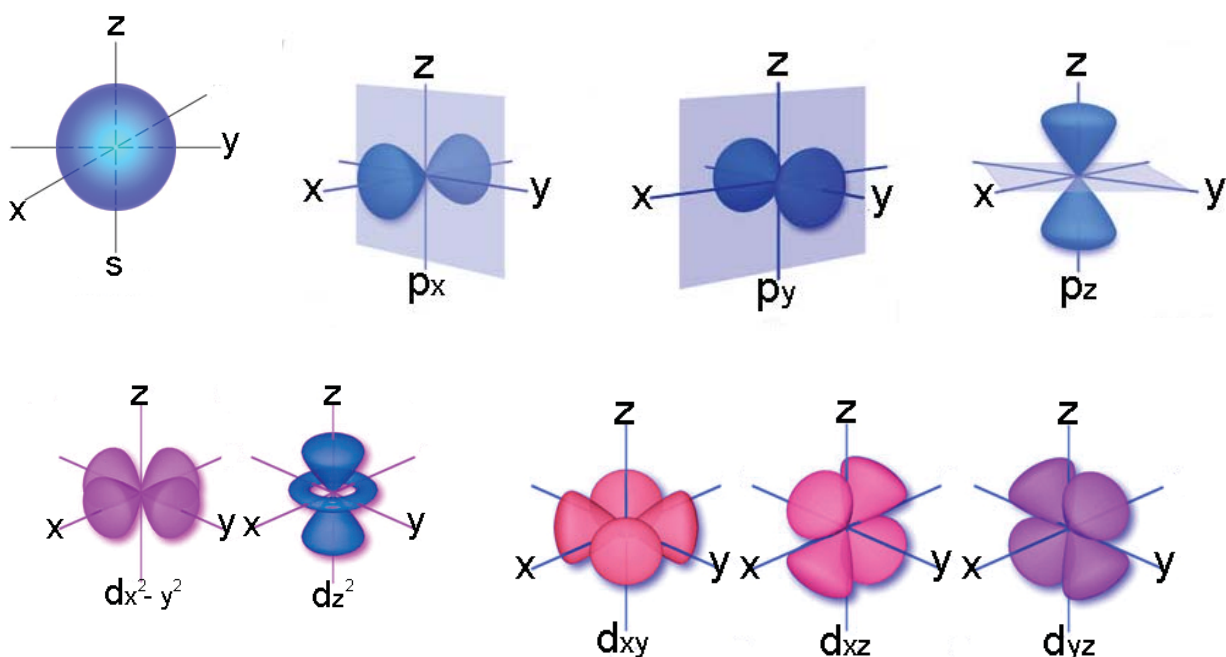

Figure 1- 4: Geometry of the orbitals

Sketch of the one s -orbital, the three p -orbitals, and the five d -orbitals. The seven f -orbitals are not shown. The “names” of the different orbitals are given below each orbital.

In the following example we are going to look at the designation of letters and quantum numbers for different orbitals.

Example 1- H: Quantum numbers and designations for different orbitals

We are going to list the different possible quantum numbers when the primary quantum number n has the value of 4. We are also going to assign the orbitals with letter symbols.

When $n = 4$, the angular momentum quantum number l can assume the values of 0, 1, 2 or 3. For each value of l the magnetic quantum number m_l can attain the values from $-l$ to $+l$. This is sketched in Figure 1- 5.

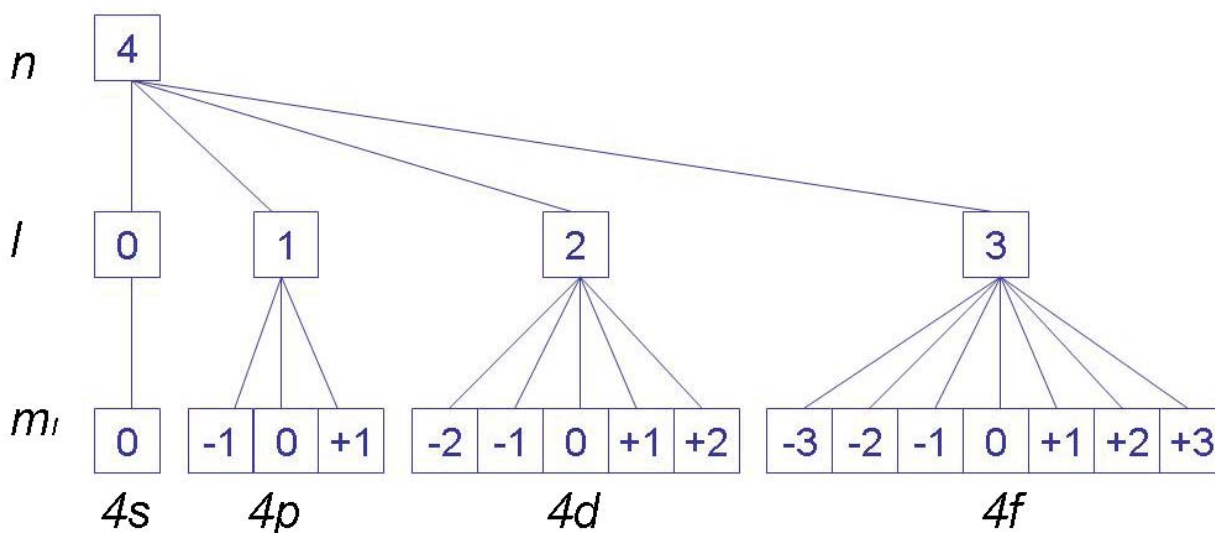

Figure 1- 5: Listing of orbitals

The individual orbitals for the primary quantum number $n = 4$.

It is thus seen that when the primary quantum number has the value of 4 it gives a total of 16 “4-orbitals” which are the *one* 4s-orbital, the *three* 4p-orbitals, the *five* 4d-orbitals, and the *seven* 4f-orbitals.

The Schrödinger's wave equation has thus resulted in a theory about orbitals that host electrons. This model is, contradictory to the atomic model of Niels Bohr, also applicable for atoms with more than one electron (elements other than hydrogen). The lines in the line spectra are explained by postulating that an atom in excited state have one or more electrons that have “jumped” to an outer atomic orbital with larger energy level. When this or these electrons then “jump” back into the orbitals of lower energy, energy is emitted in the form of photons. The energy (wavelength) of these photons then corresponds to the energy difference between the two affected orbitals and hence only light with certain wavelengths can be emitted when for example element samples are burned. This is pretty much the same principle as explained by Niels Bohr, the difference is just that the electrons are “now” hosted in orbitals instead of circular orbits.

It is important to emphasize that orbitals are “volumes” in which the electrons with a certain probability can be found. Orbitals are derived from mathematical models and the concept of orbitals is developed in order to be able to explain certain characteristics of atoms such as line spectra. Thus we are talking about theoretical and mathematical description of probabilities of finding electrons in certain position and this description has turned out to be useful to explain certain characteristics. In

chapter 2 we will see that the orbital theory is also very useful in describing how different atoms join together and form chemical bonds which lead to the formation of molecules.

1.2 Construction of the periodic table

In section 1.1 1.1 *Atomic nucleus, electrons, and orbitals* we saw that an atom in its ground state consists of an equal amount of electrons and protons and that the electrons are located around the nucleus in different orbitals. These orbitals have different levels of energy which determine where the individual electrons will be hosted. In this section we are going to look at how the elements are arranged the periodic table and why the periodic table has its actual configuration.

1.2.1 Aufbau principle

The elements in the periodic table are placed according to increasing atomic numbers. The atomic number corresponds to the number of protons in the nucleus which also corresponds to the number of electrons surrounding the nucleus in its ground state. The horizontal rows in the periodic table are called *periods*. The first period is related to the primary quantum number $n = 1$, the second period is related to the primary quantum number $n = 2$ and so on which is sketched in Figure 1- 6.

Trust and responsibility

NNE and Pharmaplan have joined forces to create NNE Pharmaplan, the world's leading engineering and consultancy company focused entirely on the pharma and biotech industries.

Inés Aréizaga Esteva (Spain), 25 years old
Education: Chemical Engineer

– You have to be proactive and open-minded as a newcomer and make it clear to your colleagues what you are able to cope. The pharmaceutical field is new to me. But busy as they are, most of my colleagues find the time to teach me, and they also trust me. Even though it was a bit hard at first, I can feel over time that I am beginning to be taken seriously and that my contribution is appreciated.

Please click the advert



NNE Pharmaplan is the world's leading engineering and consultancy company focused entirely on the pharma and biotech industries. We employ more than 1500 people worldwide and offer global reach and local knowledge along with our all-encompassing list of services.
nnepharmaplan.com

nne pharmaplan®

	MAIN GROUP ELEMENTS										MAIN GROUP ELEMENTS							
1st period	H															He		
2nd period	Li	Be										B	C	N	O	F	Ne	
3rd period	Na	Mg										Al	Si	P	S	Cl	Ar	
4th period	K	Ca	Sc	Ti	V	Cr	Mn	Fe	Co	Ni	Cu	Zn	Ga	Ge	As	Se	Br	Kr
5th period	Rb	Sr	Y	Zr	Nb	Mo	Tc	Ru	Rh	Pd	Ag	Cd	In	Sn	Sb	Te	I	Xe
6th period	Cs	Ba	La	Hf	Ta	W	Re	Os	Ir	Pt	Au	Hg	Tl	Pb	Bi	Po	At	Rn
7th period	Fr	Ra	Ac	Rf	Db	Sg	Bh	Hs	Mt	Ds	Rg							
			LANTHANOIDS	Ce	Pr	Nd	Pm	Sm	Eu	Gd	Tb	Dy	Ho	Er	Tm	Yb	Lu	
			ACTINOIDS	Th	Pa	U	Np	Pu	Am	Cm	Bk	Cf	Es	Fm	Md	No	Lr	

Figure 1- 6: The periodic table

The dotted lines indicate where the lanthanoids and the actinoids should be inserted, as a device to prevent the table becoming too wide to fit the page. In the full-width periodic table, a gap is opened up between Ca and Sc in the 4th period and between Sr and Y in the 5th period; Lu and Lr fit in a column below Sc and Y, while La and Ac, Ce and Th, Pr and Pa, and so on form two-element columns having nothing above them in the 1st to 5th periods.

Each period is ended with one of the noble gases (He, Ne, Ar, Kr, Xe, and Rn). The noble gases are characterized by the fact that each orbital related to that specific period is filled with two electrons. This makes the noble gases particularly stable and not very reactive or willing to join into chemical compounds with other atoms. The periodic table is constructed according to the so-called Aufbau principle, by which the elements from number 1 to number 111 are built up by successively adding one more electron to an orbital, the orbital concerned at each step being the orbital with the lowest possible energy level that is not already full. The elements are thus arranged according to their so-called electron configuration, a concept we shall examine further in the following section.

1.2.2 Electron configuration

To go from one element to the next in the periodic table, one electron is added in the next available orbital with the lowest possible energy level (and one more proton will be present in the nucleus). We know that each orbital is able to host two electrons. When all the orbital of one period are filled, a new period is started according to the *aufbau principle*. The electrons that have been added since the beginning of the current period are called *valence electrons* or *bond electrons*. In Figure 1- 7 you can see in which orbitals the outer electrons of a given element are hosted. For example for the 4th period you have the following order of orbitals:

$$4^{\text{th}} \text{ period orbital order : } 4s - 3d - 4p$$

It is the valence or bond electrons that are used when atoms join together and form chemical bonds and molecules. This will be described in details in chapter 2.

1st period	1s				1s
2nd period	2s				2p
3rd period	3s				3p
4th period	4s			3d	4p
5th period	5s			4d	5p
6th period	6s	4f		5d	6p
7th period	7s	5f		6d	

Figure 1- 7: Orbitals associated with the periodic table
The different outer orbitals of the different periods and groups.

The orbitals are added with electrons according the *aufbau principle* from the left to the right in each period. The orbitals with lowest energy level are added with electrons first. The orbitals can be ordered according to increasing energy level in the following row:

$$1s < 2s < 2p < 3s < 3p < 4s < 3d < 4p < 5s < 4d < 5p < 6s < 4f < 5d < 6p < 7s < 5f < 6d \quad (1- 5)$$

The orbitals with lowest energy level are added with electrons first. The following examples sketch the electron configuration for all elements making the the *aufbau principle* and construction of the periodic table clear.

Example 1- I: Adding electrons in the 1st period

The primary quantum number n equals 1 in the 1st period which means that only one orbital appears in this period and that this is an s-orbital (see section 1.1.7 *Orbital configuration* and Figure 1- 7).

According to Pauli's exclusion principle only two electrons can be hosted in one orbital which means that only two elements can be present in the 1st period. Element number 1 is hydrogen and its electron is placed in the 1s-orbital since this orbital has the lowest energy level according to the row presented in (1- 5). Helium is element number 2 and its two electrons are also placed in the 1s-orbital. The electron configurations for the 1st period elements are written as follows:

- H , $1s^1$, hydrogen has 1 electron which is hosted in the 1s-orbital.
- He , $1s^2$, helium has 2 electrons which are hosted in the 1s-orbital.

Example 1- J: Adding electrons in the 2nd period

The 1st period is ended when the 1s-orbital is filled. The 2nd period is then started when more electrons are added. According to the row given in (1- 5) and to Figure 1- 7 the addition of electrons in the 2nd period starts with the 2s-orbital. The electron configurations look as follows:

- *Li*, $1s^2 2s^1$, lithium has 2 electrons in the 1s-orbital and 1 electron in the 2s-orbital.
- *Be*, $1s^2 2s^2$, beryllium has 2 electrons in the 1s-orbital and 2 electron in the 2s-orbital.

Beryllium has two full orbitals (1s- and the 2s-orbital) but this is not the end of the 2nd period since there are three 2p-orbitals to be filled before the period is ended. The addition of electrons in the three 2p-orbitals is to be started:

- *B*, $1s^2 2s^2 2p^1$, boron has 2 electrons in the 1s-orbital, 2 electrons in the 2s-orbital and 1 electron in one of the three 2p-orbitals.
- *C*, $1s^2 2s^2 2p^2$, carbon has 2 electrons in the 1s-orbital, 2 electron in the 2s-orbital and 2 single unpaired electrons in two of the 2p-orbitals.

According to *Hund's rule* it is most favourable in terms of energy for electrons to stay unpaired in degenerated orbitals. What does that mean?

Please click the advert

CHALLENGE YOURSELF

WWW.STUDYINSWEDEN.SE

Si.
Swedish Institute

Today's job market values ambitious, innovative, perceptive team players. Swedish universities foster these qualities through a forward-thinking culture where you're close to the latest ideas and global trends.

Whatever your career goals may be, studying in Sweden will give you valuable skills and a competitive advantage for your future. www.studyinsweden.se

For example the three 2p-orbitals are degenerated which means that they all have equal levels of energy. To put it another way; it does not matter in which of the three 2p-orbitals the last “attached” valence electron is placed in. *Hund’s rule* implies that in terms of energy it is most favourable for the electron to be placed in an empty 2p-orbital whereby the electron remains unpaired (that way the atom will be paramagnetic according to what is stated in section 1.1.6 *Wave functions and orbitals*. When all 2p-orbitals are filled with single unpaired electrons you have the element nitrogen with the following electron configuration:

- N , $1s^2 2s^2 2p^3$, according to Hund’s rule each of the three 2p-orbitals are each filled with a single unpaired electron.

To get to the next element, which is oxygen, an extra electron is filled in one of the 2p-orbitals. That way there are only two unpaired electrons left. The addition of electrons in the rest of the 2nd period is sketched below:

- O , $1s^2 2s^2 2p^4$, 2 unpaired electrons in two of the 2p-orbitals. Paramagnetic.
- F , $1s^2 2s^2 2p^5$, 1 unpaired electron in one of the 2p-orbitals. Paramagnetic.
- Ne , $1s^2 2s^2 2p^6$, all orbitals of the period are full and the period is ended. Diamagnetic.

The last attached electron or electrons in the period are (as mentioned earlier) called valence electrons or bond electrons. If fluorine is used as an example the valence electrons are the two electrons in the 2s-orbital and the five electrons in the 2p-orbitals. The two inner electrons in the 1s-orbital are not valence electrons. They are called *core electrons* instead.

Example 1- K: Adding electrons in the 3rd period

The 2nd period is ended with the noble gas neon. After neon the 3rd period is started with the 3s-orbital:

- *Na*, $1s^2 2s^2 2p^6 3s^1$, one valence electron in the 3s-orbital and 10 *core electron*.

The electron configuration for the 10 core electrons corresponds to the electron configuration for the noble gas in the previous period (in the case of sodium the core electron configuration corresponds to the electron configuration of neon). To ease the work of writing the full electron configuration, only the electron configuration of the valence electrons are written while the electron configuration for the core electrons is replaced by the chemical symbol for the previous noble gas placed in edged brackets. The electron configuration for sodium can thus more simple be written as follows:

- *Na*, $[Ne]3s^1$, one valence electron in the 3s-orbital. The electron configuration for 10 core electrons correspond the electron configuration of the noble gas neon.

The addition of valence electrons in the 3rd period is continued as in the 2nd period:

- *Mg*, $[Ne]3s^2$, 2 electrons in the 3s-orbital.
- *Al*, $[Ne]3s^2 3p^1$, 2 electrons in the 3s-orbital and one electron in one of the 3p-orbitals.
- *Si*, $[Ne]3s^2 3p^2$, 2 electrons in the 3s-orbital and 2 unpaired electrons in two of the 3p-orbitals.
- *P*, $[Ne]3s^2 3p^3$, 2 electrons in the 3s-orbital and 3 unpaired electrons in three of the 3p-orbitals.
- *S*, $[Ne]3s^2 3p^4$, 2 electrons in the 3s-orbital and 4 electrons in the 3p-orbitals.
- *Cl*, $[Ne]3s^2 3p^5$, 2 electrons in the 3s-orbital and 5 electrons in the 3p-orbitals.
- *Ar*, $[Ne]3s^2 3p^6 = [Ar]$, all orbitals of the period are full and we have reached the end of the 3rd period.

Example 1- L: Adding electrons in the 4th period

The addition of valence electrons through the 4th period takes place almost as in the 3rd period. The exception is that after the addition of the 4s-orbital, the five 3d-orbitals are then filled before the filling of the three 4p-orbitals according to the row given in (1- 5) and Figure 1- 7. This is due to the fact that in between the energy levels of the 4s-orbital and the 4p-orbitals the energy level of the five 3d-orbitals is located. During the addition of the five 3d-orbitals, Hund's rule is again followed which means that as long as there are empty 3d-orbitals, the "next" electron will be placed in an empty orbital and thus remain unpaired. Some examples of electron configuration for elements from the 4th period are given here:

- *Ti*, $[Ar]4s^2 3d^2$, 2 electrons in the 4s-orbital and 2 electrons in the 3d-orbitals.
- *Zn*, $[Ar]4s^2 3d^{10}$, all five 3d-orbitals are full.
- *Ga*, $[Ar]4s^2 3d^{10} 4p^1$, the addition of electrons to the three 4p-orbitals has started.
- *Kr*, $[Ar]4s^2 3d^{10} 4p^6 = [Kr]$, all the orbitals of the period are full and the period is ended.

Please click the advert

THE MILKWAY
LAUNCHING GRADUATE CAREERS

MILKROUND SYSTEM
Become a business star with internships, placements, graduate jobs & schemes from leading companies.
www.milkround.com

PLANET CAREER ADVICE
Inhabited by insights into business careers and orbited by application advice.

FIRST CONTACT
Get matched to top business employers via intelligent emails landing in your inbox.

Milkround.com: rated the #1 graduate recruitment website in the UK Graduate Careers Survey 2009 of 16,000 university finalists.

Milkround.com

Download free books at BookBooN.com

In the 4th period there are some exceptions for some of the elements where the electron configuration deviates for the conventional principle of “addition of electrons to orbitals”. These exceptions are:

- *Cr*, $[Ar]4s^1 3d^5$, only *one* electron in the 4*s*-orbital while all five 3*d*-orbitals each host one unpaired electron. This configuration is particularly stable for the d-orbitals.
- *Cu*, $[Ar]4s^1 3d^{10}$, only *one* electron in the 4*s*-orbital while all five 3*d*-orbitals each host two electrons. This configuration is particularly stable for the d-orbitals.

Example 1- M: Adding electrons in the 5th period

The addition of electrons through the 5th period takes place exactly as for the 4th period. First the 5*s*-orbital is filled and then the five 4*d*-orbitals are filled. Finally the three 5*p*-orbitals are filled according to the row given in (1- 5) and Figure 1- 7. In the 5th period there are also some deviations for the normal addition of electron principles in which the five 4*d*-orbitals are either half or completely full with electrons before the 5*s*-orbital is filled. These deviations are similar to the deviations in the 4th period:

- *Mo*, $[Kr]5s^1 4d^5$, only *one* single electron in the 5*s*-orbital while all five 4*d*-orbitals each host one unpaired electron. This gives a particular stable electron configuration for the *d*-orbitals.
- *Pd*, $[Kr]5s^0 4d^{10}$, *no* electrons in the 5*s*-orbital while all five 4*d*-orbitals each host two electrons. This gives a particular stable electron configuration for the d-orbitals
- *Ag*, $[Kr]5s^1 4d^{10}$, only *one* single electron in the 5*s*-orbital while all five 4*d*-orbitals each host two electrons. This gives a particular stable electron configuration for the *d*-orbitals.

Example 1- N: Adding electrons in the 6th and 7th period

In the 6th and 7th period the seven f-orbitals are introduced (the 4f-orbitals and the 5f-orbitals respectively) which is also sketched in (1- 5) and Figure 1- 7. This means that in the 6th period the 6s-orbital is filled first and then the seven 4f-orbitals are filled. After that the five 5d-orbitals are filled followed by the addition of electrons of the three 6p-orbitals. In the 7th period the 7s-orbital is filled first followed by the filling of the seven 5f-orbitals. After that the five 6d-orbitals are filled and then no more elements exist (or at least they have not been found or synthesized yet).

Here are some examples of electron configurations for 6th and 7th period elements. Europium (Eu), gold (Au), lead (Pb), and einsteinium (Es) are used as examples:

– *Eu*, $[Xe]6s^2 4f^7$, core electron configuration corresponds to the noble gas xenon. Besides that 2 electrons are in the 6s-orbital and 7 unpaired electrons in each of the seven 4f-orbitals.

– *Au*, $[Xe]6s^1 4f^{14} 5d^{10}$, core electron configuration corresponds to the noble gas xenon.

Besides that *one* electron is in the 6s-orbital, 14 electrons in the 4f-orbitals and 10 electrons in the 5d-orbitals. It is seen that the electron configuration of gold deviates from the normal “addition of electrons to orbitals” principle since only *one* electron is in the 6s-orbital the 5d-orbitals are filled. But as described for the 4th and 5th period this gives a particular stable configuration for the d-orbitals.

– *Pb*, $[Xe]6s^2 4f^{14} 5d^{10} 6p^2$, core electron configuration corresponds to the noble gas xenon. Besides that 2 electrons in the 6s-orbital, 14 electrons in the 4f-orbitals, 10 electrons in the 5d-orbitals, and 2 electrons in the 6p-orbital.

– *Es*, $[Rn]7s^2 5f^{11}$, core electron configuration corresponds to the noble gas radon. Besides that there are 2 electrons in the 7s-orbital and 11 electrons in the 5f-orbitals.

The elements with 4f-orbital valence electrons are called *lanthanoids* because the last element before the 4f-orbitals is lanthanum (La). The elements with 5f-orbital valence electrons are called *actinoids* since the last element before the 5f-orbitals is actinium (Ac).

1.2.3 Categorization of the elements

The elements in the periodic table can be classified as either

- Metals
- Metalloid
- None-metal

The metals are placed to the left while the none-metals are placed to the right in the periodic table. The metalloids are placed as a wedge between the metals and the none-metals as sketched in Figure 1- 8.

ALKALI METALS (NOT HYDROGEN) NOBLE GASES

↓ ALKALINE EARTH METALS HALOGENS ↓

1.	H																			He
2.	Li	Be										B	C	N	O	F				Ne
3.	Na	Mg										Al	Si	P	S	Cl				Ar
4.	K	Ca	Sc	Ti	V	Cr	Mn	Fe	Co	Ni	Cu	Zn	Ga	Ge	As	Se	Br			Kr
5.	Rb	Sr	Y	Zr	Nb	Mo	Tc	Ru	Rh	Pd	Ag	Cd	In	Sn	Sb	Te	I			Xe
6.	Cs	Ba	La	Hf	Ta	W	Re	Os	Ir	Pt	Au	Hg	Tl	Pb	Bi	Po	At			Rn
7.	Fr	Ra	Ac	Rf	Db	Sg	Bh	Hs	Mt	Ds	Rg									

METAL NON-METAL METALLOID

TRANSITION METALS

LANTHANOIDS

Ce	Pr	Nd	Pm	Sm	Eu	Gd	Tb	Dy	Ho	Er	Tm	Yb	Lu
----	----	----	----	----	----	----	----	----	----	----	----	----	----

ACTINOIDS

Th	Pa	U	Np	Pu	Am	Cm	Bk	Cf	Es	Fm	Md	No	Lr
----	----	---	----	----	----	----	----	----	----	----	----	----	----

Figure 1- 8: Categorization of the elements in the periodic table

The elements can be categorized as metals, metalloids, or none-metals. Common names for some of the vertical groups are given as well.

Please click the advert



oxygen.ie

Download 3rd level revision guides for free
– brought to you by oxygen.ie

One of the most important differences between metals and non-metals is that metals have very high electrical conductance in all directions. Carbon for example in the form of graphite only conducts electricity in two dimensions inside the layered structure and is thus characterized as a non-metal. Metals and non-metals also behave very differently in association with chemical reactions and the formation of chemical bonds. When a metal reacts with a non-metal, the metal will normally deliver electrons to the non-metal which transforms the metal atom into a cation. The non-metal is thus transformed into an anion and the chemical bond will thus be ionic. The metalloids are placed as a wedge between the metals and non-metals. The metalloids exhibit both metal and non-metal characteristics.

The vertical rows in the periodic table are called groups. The elements with the “last attached” electron in a d-orbital are called transition metals while the lanthanoids and actinoids have their “last attached” electron in the 4f-orbitals and 5f-orbitals, respectively. The other groups are normally called *main groups*. Some of these groups have common names which are shown in Figure 1- 8. The transition metals in the “middle” (closest to manganese (Mn), Technetium (Tc) and Rhenium (Re)) are generally characterized by the ability to appear in many different oxidation states, whereas the main group elements in general only are able to appear in one or two different oxidation states besides the oxidation state of zero. This is exemplified in the following example:

Example 1- O: Oxidation state (transition metal and main group element)

Transition metals are among other aspects characterized by the ability to appear in many oxidation states. The transition metal osmium can be used as an example:

Os, Possible oxidation states of osmium: 0, +2, +3, +4, +6, +8

It is thus seen that osmium can attain six different oxidation states. On the other hand main group elements are generally not able to attain that many different oxidation states. Tin for example can only attain two different oxidation states (besides from zero):

Sn, Possible oxidation states of tin: 0, +2, +4

The general trend is that transition metals can attain many different oxidation states which is contradictory to main group elements that in general only can attain a few different oxidation states.

1.2.4 Periodic tendencies

Different tendencies for the elements exist for the periods (horizontal rows) in the periodic table and different tendencies exist in the groups (vertical rows) in the periodic table. In this section we will look more at the periodic tendencies for the following three terms:

- Atomic radius
- Ionization energy
- Electron affinity

The general trends will be described in this section and only some of the exceptions that appear in the periodic table will be discussed. For more details about all exceptions you should seek the knowledge in more detailed educational textbooks.

The radius of an atom decreases when you go from the left to the right through a period. This is because when one moves one position to the right (for example when going from lithium to beryllium) one more proton is “added” to the atomic nucleus. Also one electron is “added”. This extra electron will just be hosted in one of the existing orbitals of the period and will not lead to an increased volume. However, the “extra” proton in the nucleus will increase the total positive charge of the nucleus by “+1”. This means that the increased positive charge will drag the electrons closer to the nucleus and the total volume and atomic radius will thus decrease.

Please click the advert



DIVERSE - INNOVATIVE - INTERNATIONAL

Are you considering a European business degree?

Copenhagen Business School is one of the largest business schools in Northern Europe with more than 15,000 students from Europe, North America, Australia and Asia.

Are you curious to know how a modern European business school competes with a diverse, innovative and international study environment?

Please visit Copenhagen Business School at www.cbs.dk

 **Copenhagen Business School**
HANDELSHØJSKOLEN

Diversity creating knowledge

When you move down a group (vertical row) in the periodic table the atomic radius will of course increase since the atom just below has more electrons and a set of orbital more (*s*- and *p*-orbitals and in lower rows *d*- and *f*-orbitals). When you move one position down, the primary quantum number n will increase by 1 and this means that the orbitals for that particular quantum number are larger which results in a larger atomic radius since the valence electrons are then placed further away from the nucleus. We will look more at atomic radius in the following example:

Example 1- P: Atomic radius

When you move through a period from the left to the right the atomic radius will decrease. This is sketched for the 3rd period in Figure 1- 9.

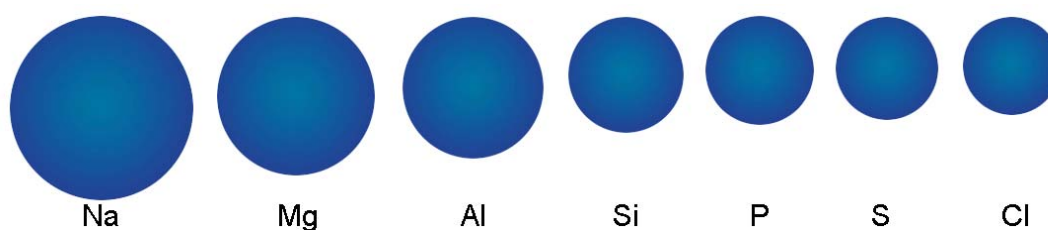

Figure 1- 9: Relative atomic radius for 3rd period elements

Relative atomic radius for the elements in the 3rd period of the periodic table.

It is seen that the atomic radius for sodium is almost the double of that of chlorine. When you move down a group (vertically down) the atomic radius increases which is sketched in Figure 1- 10 for the elements in the 1st main group.

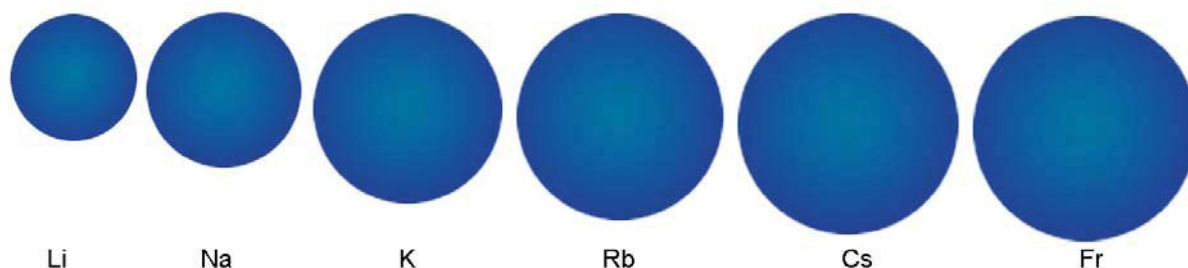

Figure 1- 10: Relative atomic radius for 1st main group elements

Relative atomic radius for the elements in the 1st main group.

In Figure 1- 10 it is seen that the relative atomic radius for the elements in the 1st main group (alkali metals) increases which is the case for all vertically groups.

Now we are going to look at ionization energy. When we talk about ionization energy it is implicitly understood that we are talking about the 1st ionization energy. The 1st ionization energy is the amount of energy required to remove one single electron away from the atom. When one electron is removed, the atom becomes a positively charged ion (a cation). Tin and boron can be used as examples:



Thus 708.2 and 800.6 kilo joules are required to ionize 1 mole of tin and boron atoms, respectively. Electrons are easier to remove when they are further away from the nucleus, so the ionization energy decreases. Furthermore the electrons closer to the nucleus constitute a kind of shielding or screening for the outer electrons. This shielding further reduces the strength of the attraction exerted by the nucleus on the outer electrons, so again they are therefore easier to remove and the ionization energy is lower.

Please click the advert



Sharp Minds - Bright Ideas!

Employees at FOSS Analytical A/S are living proof of the company value - First - using new inventions to make dedicated solutions for our customers. With sharp minds and cross functional teamwork, we constantly strive to develop new unique products - Would you like to join our team?

FOSS works diligently with innovation and development as basis for its growth. It is reflected in the fact that more than 200 of the 1200 employees in FOSS work with Research & Development in Scandinavia and USA. Engineers at FOSS work in production, development and marketing, within a wide range of different fields, i.e. Chemistry, Electronics, Mechanics, Software, Optics, Microbiology, Chemometrics.

We offer
A challenging job in an international and innovative company that is leading in its field. You will get the opportunity to work with the most advanced technology together with highly skilled colleagues.

Read more about FOSS at www.foss.dk - or go directly to our student site www.foss.dk/sharpminds where you can learn more about your possibilities of working together with us on projects, your thesis etc.

The Family owned FOSS group is the world leader as supplier of dedicated, high-tech analytical solutions which measure and control the quality and production of agricultural, food, pharmaceutical and chemical products. Main activities are initiated from Denmark, Sweden and USA with headquarters domiciled in Hillerød, DK. The products are marketed globally by 23 sales companies and an extensive net of distributors. In line with the corevalue to be 'First', the company intends to expand its market position.





Dedicated Analytical Solutions

FOSS
 Slangerupgade 69
 3400 Hillerød
 Tel. +45 70103370
www.foss.dk



Example 1- Q: Ionization energy

The ionization energy increases when you move from the left to the right in a period. In Figure 1- 11 the ionization energies for the elements of the 2nd period are showed as an example. The ionization energy decreases when you move down a group in the periodic table. This is also shown in Figure 1- 11 for the elements of the 1st main group (the alkali metals).

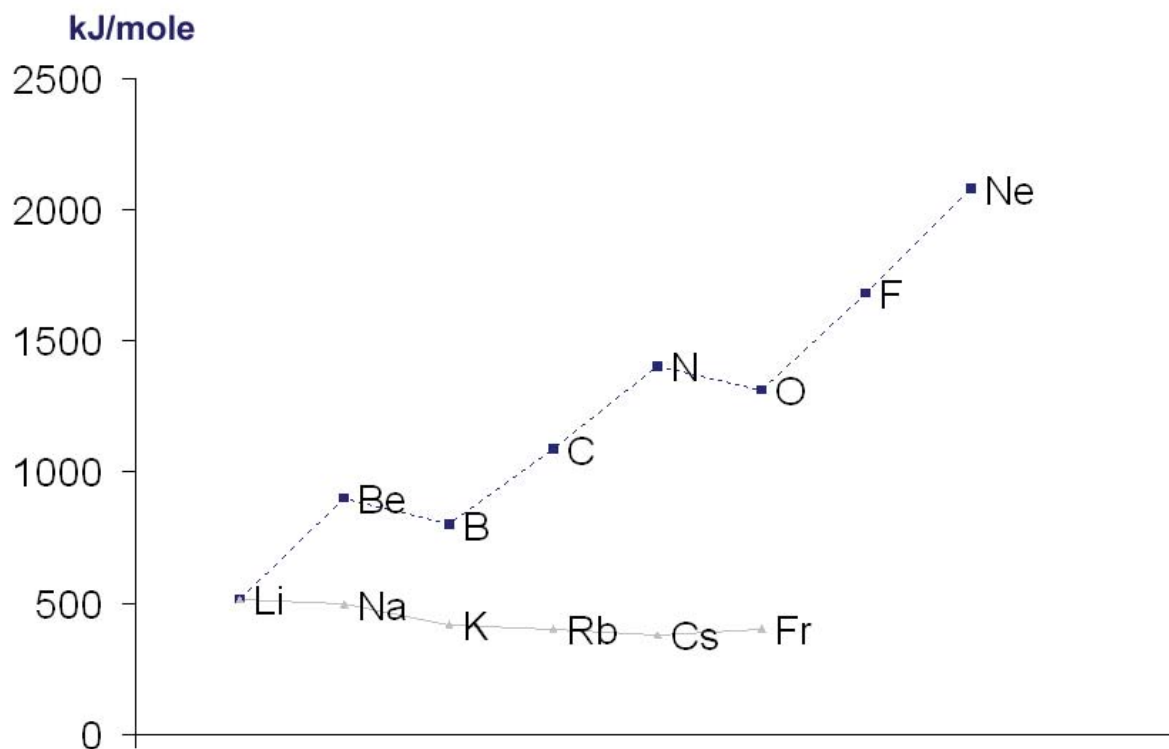
**Figure 1- 11: Ionization energy**

Ionization energy for the elements in the 2nd period (Li, Be, B, C, N, O, F, and Ne) and for the elements in the 1st main group (Li, Na, K, Rb, Cs, and Fr).

Two exceptions are clear by looking at Figure 1- 11. When you go from beryllium to boron the ionization energy actually decreases. This is because the valence electron of boron in one of the 2p-orbitals is easier to remove than one of the valence electrons of beryllium in the 2s-orbital. The two electrons in the beryllium 2s-orbital constitute a particularly stable electron configuration and the ionization energy is thus relatively large. Nitrogen has three unpaired electrons in each of the degenerated 2p-orbitals which (as described in the section 1.2.2 *Electron configuration*) gives a particularly stable electron configuration. Hence more energy is required to remove one of these unpaired 2p-electrons than the amount of energy required to remove one of the paired 2p-electrons of the oxygen atom. Therefore the ionization energy of oxygen is lower than for nitrogen.

Overall it is seen that the increasing tendency of ionization energy for the periods is much larger than the decreasing tendency down the vertical groups.

Electron affinity is defined as the energy change when an electron is "absorbed" by an atom. Fluorine can be used as an example:



Since the electron affinity is negative, 328 kilo joules are released when 1 mole of electrons are attached to 1 mole of fluorine atoms. This relatively large number is caused by the very high electronegativity of fluorine. It tells something about the tendency for the atom to accept an extra electron. Electron affinity is thus related to the electronegativity of the elements. In Figure 1- 12 the relative electronegativity for the elements in the periodic table is sketched.

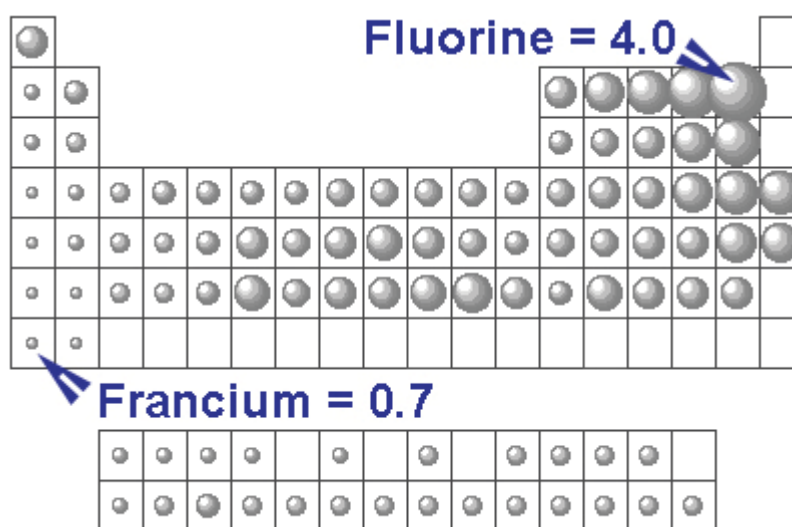

Figure 1- 12: Electronegativity

Electronegativity of the elements in the periodic table. The size of the "bubbles" corresponds to the relative level of the electronegativity. Fluorine has the largest electronegativity (4.0) and francium has the lowest electronegativity (0.7).

The larger electronegativity the more the atom "wants" to adopt an extra electron and the larger a numerical value of the electron affinity. It shall be noticed that all elements have positive electronegativities which means that in principle it is favourable, in terms of energy, for all elements to adopt an electron. But here it shall be noted that this extra electron has to be supplied from another atom and that this atom thus has to be lower in electronegativity in order for the total energy to be lowered. In the following example we are going to look more at electronegativities and electron affinities.

Example 1- R: Electronegativity

You have a rubidium atom (Rb) and an iodine atom (I). Both have positive electronegativities which mean that both in principle want to adopt an extra electron. Which of the atoms will become a cation and which will become an anion if they react with each other? Which of the atoms have greatest electronegativity?

Rubidium has an electronegativity of 0.8 and iodine has an electronegativity of 2.5. Thus iodine is more likely to adopt an electron than rubidium. Thus rubidium will be forced to deliver an electron to iodine during a chemical reaction.

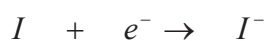

Because iodine has larger electronegativity than rubidium, the numerical value of the electron affinity for iodine will be larger than for rubidium. This is the reason that during chemical reaction the iodine atom will become the anion (iodide) and rubidium will become the cation (rubidium ion).

1.3 Summing up on chapter 1

In this first chapter the fundamental terms and aspects of education within chemistry have been introduced. We have been looking at single atoms and their components namely the nuclei (protons and neutrons) and the surrounding electrons. The challenge in describing the motion of the electrons relative to the atomic nucleus has been introduced by use of different theories and models. These theories and models all aim at the ability to explain the different lines in the line spectra for the different elements. The atomic model derived by the Danish scientist Niels Bohr is presented followed by quantum mechanical considerations leading to the description of electrons in motion either as particles in motion or as electromagnetic waves. From that the description of the atomic orbitals emerges. These orbitals can be visualized as “volumes” at certain locations around the nucleus with larger possibility of finding the electrons that are hosted in the orbitals. With these orbitals as a launching pad, the so-called *aufbau principle* is presented. The orbitals with the lowest energy level will be “added” with electrons first and this leads to the construction of the periodic table. Thus the electron configurations of the elements are closely related to the construction of the periodic table. A categorization of the elements as metals, metalloids, or non-metals is also given and examples of different periodic tendencies are given related to different terms such as atomic radius, ionization energy, electronegativity, and electron affinity.

In the next chapter we will move from single atoms to chemical compounds which consist of more than one atom. We are going to look at chemical bonds and molecules.

2. Chemical compounds

In chapter 1 we saw how the elements (single atoms) are arranged in the periodic table according to in which orbitals the valence electrons are hosted. The orbitals have been described as well. In this chapter we will use our knowledge about atomic orbitals to answer the following question:

Why do two hydrogen atoms join and form a H_2 molecule when for example two helium atoms rather prefer to stay separate than to form a He_2 molecule?

We are also going to look at the geometry of different molecules by using orbital theory. That way we can find the answer to the following question:

*Why is a CO_2 molecule linear ($O-C-O$ angle = 180°)
when a H_2O molecule is V-shaped ($H-O-H$ angle $\neq 180^\circ$)?*

When we have been looking at different molecules we are going to move into the world of metals. In metals the atoms are arranged in lattice structures. By looking at these different lattice structures it will be clear why metals have such high electrical conductance in all directions. We will also look at structures in solid ionic compounds like common salt which have great similarities with the metallic structures.

Please click the advert

**Design your
own future at
MAN Diesel**

www.mandiesel.com

MAN Diesel – Powering the World



Download free books at BookBooN.com

2.1 Bonds and forces

Initially it is a good idea to introduce the different types of bonds that bind atoms together in molecules (intramolecular forces), metal, and ionic lattices. After that we are going to look at forces that interact between molecules (intermolecular forces).

2.1.1 Bond types (intramolecular forces)

Chemical bonds are composed of valence electrons from the atoms that are bound together. There are three types of chemical bonds:

- Covalent bonds
 - Ionic bonds
 - Metal bonds
- } Intramolecular forces

In a *covalent bond* two atoms share an electron pair. Each atom supplies one electron to this electron pair. When we are dealing with two identical atoms, the chemical bond is purely covalent. If the two atoms are not the same the most electronegative atom (see section 1.2.4 *Periodic tendencies*) will attract the electron pair more than the less electronegative atom. Thus the electron density around the most electronegative atom will be higher than the electron density around the less electronegative atom. In this case the covalent bond can be considered as a so-called *polar covalent bond*. When the difference in electronegativity between the two atoms reaches a certain level, the electron pair will almost exclusively be present around the most electronegative atom which will then be an anion. The less electronegative atom will then be a cation since it has almost completely “lost” its binding valence electron. This type of bond is called an *ionic bond* and it can be considered as consisting of electrostatic interactions between a cation and an anion rather than the sharing an electron pair. The transition from pure covalent bond over polar covalent bond to ionic bond is thus a continuous gradient of polarity (rather than a distinct differentiation) which is sketched in Figure 2- 1.

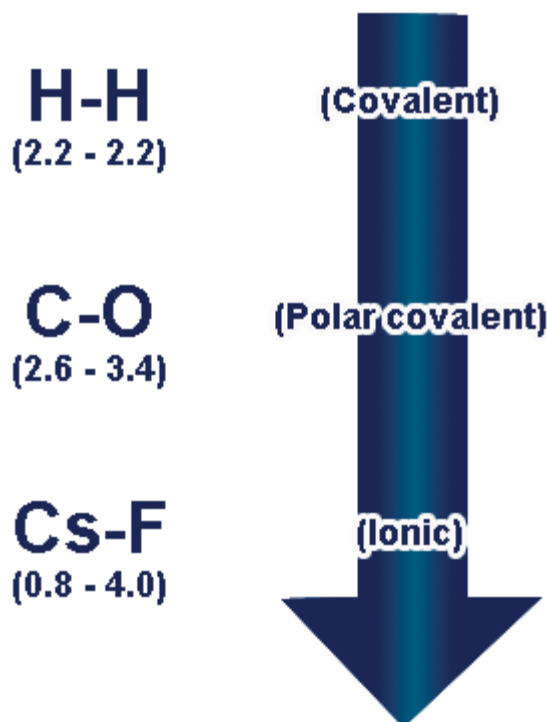

Figure 2- 1: From covalent to ionic bonds

The transition from covalent to ionic bonds is a continuous gradient of polarity and depends on the difference between the electronegativity of the atoms. The electronegativities are given in parenthesis below the sketched examples of bonds.

We have metal bonds when the metal atoms are placed in a three-dimensional lattice. In such a lattice the bond electrons “flow” around in all directions in the lattice which results in a very high electrical conductance in all directions. We have now been talking about *intramolecular* forces. The different bond types will be described in the following sections but first we are going to look at the *intermolecular* forces that interact *between* the molecules and not *inside* molecules.

2.1.2 Intermolecular forces

It is very important not to confuse the two terms *intramolecular forces* and *intermolecular forces*. Intramolecular forces are forces that act *inside* molecules and thus constitute the bonds between atoms. Intermolecular forces, on the other hand, are forces that act *outside* the molecules between molecules. The energies of chemical bonds (intramolecular forces) are much higher than the energies related to the intermolecular forces. Three different types of intermolecular forces can be distinguished:

- Dipole - dipole forces
 - Hydrogen bonds
 - London forces
- } Intermolecular forces

Intermolecular forces (to a more or minor extent) hold molecules together. If the intermolecular forces did not exist, all molecular compounds would be gases. In a molecule consisting of two different atoms the bond electron pair will by average be present mostly around the atom with the highest electronegativity as we saw in the section 2.1.1 *Bond types*. Thus we have a polar covalent or ionic bond and the molecules have a dipole moment. This leads to the existence of dipole-dipole forces acting between the molecules.

Example 2- A: Dipole-dipole forces among HCl molecules

In Figure 2- 2 the dipole-dipole forces acting between hydrogen chloride molecules in the gas state are sketched.

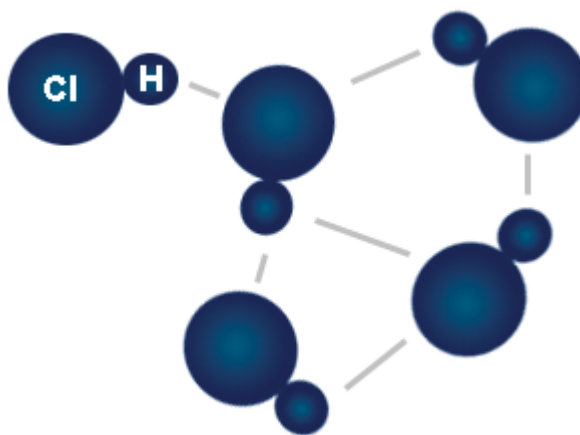

Figure 2- 2: Dipole-dipole forces among HCl molecules

The bond electron pair will by average be located most of the time closest to the chlorine atom because of the larger electronegativity. Thus the chlorine atom in the molecule constitutes a negative pole while the hydrogen atom comprises the positive pole. Dipole-dipole interactions among the molecules are sketched by the grey lines.

Dipole-dipole forces act between the molecules because the negative end of one molecule will attract the positive end of another molecule. Dipole-dipole forces can comprise up to 1 % of the forces that act between to atoms in a covalent bond. Thus intermolecular dipole-dipole forces are very week compared to intramolecular covalent bond forces.

A hydrogen bond is a special strong kind of a dipole-dipole force. Actually hydrogen bonds are by far the strongest kind of intermolecular forces. A hydrogen bond can comprise up to almost 20 % of the forces that exist between two atoms in a covalent bond. Hydrogen bonds can exist in the following contexts:

- From an H atom to an N atom in the neighbour molecule
- From an H atom to an O atom in the neighbour molecule
- From an H atom to an F atom in the neighbour molecule

The hydrogen atom in the hydrogen bond constitutes the positive pole while the N, O, or F atom constitutes the negative pole.

Please click the advert

The advertisement features a light blue background with a central graphic. The graphic consists of four icons arranged horizontally, separated by plus and equals signs. From left to right: a shopping cart icon on a dark grey background labeled 'Student Discounts'; a calendar icon on a blue background labeled 'Student Events'; a pound sterling symbol (£) on a grey background labeled 'Money Saving Advice'; and a yellow envelope icon with three stars on a yellow background labeled 'Happy Days!'. Below the icons, the text 'wealthystudent.co.uk' is displayed in a dark grey font, with 'wealthy' in a larger, bold font and 'student.co.uk' in a smaller font.

Example 2- B Hydrogen bonds between water molecules

Hydrogen bonds play a great role in water. In Figure 2- 3 hydrogen bonds between water molecules are sketched.

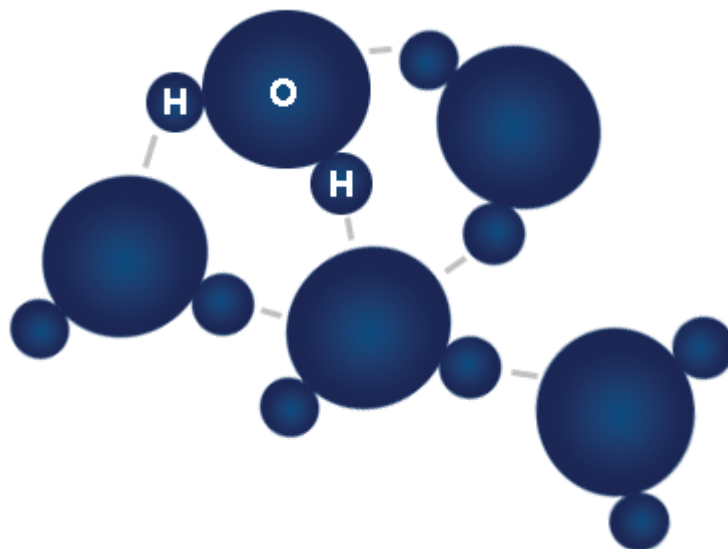

Figure 2- 3: Hydrogen bonds between water molecules

Hydrogen bonds between hydrogen atoms and oxygen atoms in neighbour molecule are sketched by the grey lines.

It is the hydrogen bonds in water that gives the relative large boiling point of water. Hydrogen bonds can comprise the energy amount of almost 20 % of that of a covalent bond.

Hydrogen bonds also have great biological importance since they, among other factors, contribute to the maintenance of the helical structure of DNA.

London forces are named after the scientist Fritz London. London forces are a type of forces that exists among *all* kinds of molecules. While dipole-dipole forces only acts between molecules with dipole moments and hydrogen bonds only acts between molecules containing hydrogen and either nitrogen, oxygen, or fluorine, London forces act between *all* kinds of molecules. It is London forces that bind molecules which on the outside appears unpolar (no dipole moment) together. The electron cloud that surrounds an atom or a molecule with no dipole moment will on an average be equally distributed around the whole atom or molecule. But if you look at the electron cloud at a specific time, the electron cloud will be displaced. You can say that the electron cloud “laps” around the atom or molecule like waves at the oceans thus inducing momentarily dipole moments. These momentary dipole moments can momentary interact with the momentary dipole moment in the neighbour molecule. These interactions are called London forces.

Example 2- C: London forces between hydrogen molecules

Hydrogen molecules on the outside have no dipole moments. Even so some forces act between the hydrogen molecules. These forces are the London forces and they exist because the electron clouds in the hydrogen molecules “lap” around and induce momentary dipole moments that momentary can interact with each other and thus “drag” the molecules together. This is sketched in Figure 2- 4.

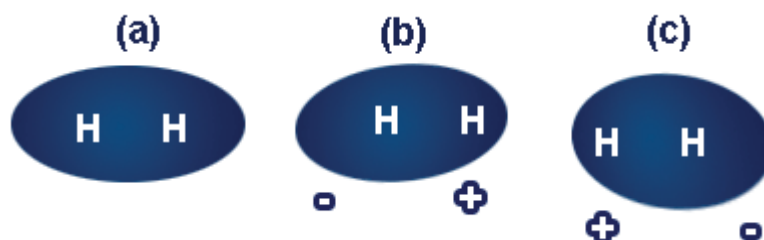

Figure 2- 4: London forces between hydrogen molecules

(a) By average the electron cloud is distributed equally around the H-H bond. Thus by average there is no dipole moment. (b) At a given time the electron cloud will be displaced so that there will be a momentary dipole moment. (c) At another given time the electron cloud will be displaced in another way so that a “new” dipole moment will be induced. Interactions between momentary dipole moments are called London forces.

The more electrons that are present in the molecule the more the electrons can “lap” around and the larger momentary dipole moments will be induced. Therefore London forces are larger between larger molecules.

Till now in this chapter we have very briefly been looking at the different types of bonds that can exist between two atoms (intramolecular forces) and at the different types of forces that can act between molecules (intermolecular forces). In the following sections we are going to look more detailed into the different types of chemical bonds. That way we will be able to explain why it is beneficial for some atoms to join in a chemical bond and why this is not the case for other atoms.

2.2 Covalent bonds

In this section we are going to look at the nature of covalent bonds.

- Why do covalent bonds form?
- Which structures do molecules with covalent bonds adopt?

These questions and other aspects concerning energy considerations, molecular orbital theory, Lewis structures, VSEPR theory, and orbital hybridization theory will be answered and covered in this section.

2.2.1 Energy considerations

When two atoms join and form a molecule by creating a covalent bond, it always happens because in terms of energy it is favourable. The total energy can be lowered by creating the covalent bond and this is the reason that the bond is formed.

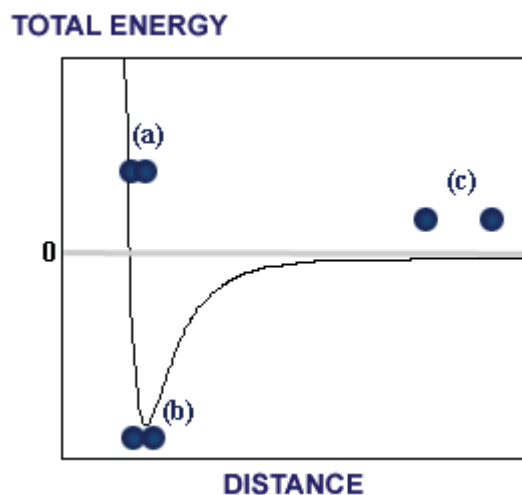

Figure 2- 5: Energy profile

The total energy between two hydrogen atoms as a function of their distance. (a) When the two hydrogen atoms are forced close together the potential energy increases very dramatically similar to when two north pole magnets are forced together. (b) At a certain distance (which is the bond length) between the two hydrogen atoms there is a minimum in energy. (c) When the two hydrogen atoms are far away from each other the energy is zero which corresponds to no bond.

Please click the advert

THE SPANNER

Read The Spanner online on oxygen.ie

Download free books at BookBooN.com

In the graph on Figure 2- 5 it is seen that at a certain distance between the two atomic nuclei the total energy has a minimum. This distance corresponds to the bond length of the covalent bond between the atoms. When the two atoms are far apart from each other the total energy is zero which corresponds to the existence of no bond at all. If the two atoms are forced together (closer together than the bond length), the total energy will increase dramatically and the atoms will repel each other. This can be compared to when two north pole (or south pole) magnets are forced together. The potential energy will increase very much and they will repel each other.

2.2.2 Molecular orbital theory

The energy profile in Figure 2- 5 shows that at a certain distance between the atoms there is a minimum in energy which corresponds to the bond length of the covalent bond. However, we still know nothing about how and where the two electrons of the bonding electron pair are located. It is also seen in Figure 2- 5 when going from the right to the left that when two atoms approach each other the energy will be minimized when approaching the bond length. How can this be explained?

Molecular orbital theory can be used to explain why some atoms form molecules and why others do not¹.

When two atoms approach each other the atomic orbitals will "melt" together and new so-called *molecular orbitals* will be formed. In these molecular orbitals the bond electrons of the covalent bond will be hosted. There are two types of molecular orbitals:

- *Bond orbitals*, denoted with the Greek letter σ
- *Anti-bond orbitals*, denoted with σ^*

The bond orbitals have lower energy levels compared to the anti-bond orbitals. As for the atomic orbitals these molecular orbitals are each able to host two electrons. In the following example we are going to see how the atomic orbitals of two hydrogen atoms "melt" together and form two molecular orbitals during the formation of a hydrogen molecule.

¹ When we are talking about orbitals (as in chapter 1) it is important to notice that we are talking about mathematical models that are able to explain different physical and chemical phenomena. It is not necessarily evidenced that the actual physical and chemical conditions are in agreement with the models but the models are just efficient in explaining certain behaviors, tendencies, and conditions.

Example 2- D: Molecular orbitals in the hydrogen molecule

The hydrogen molecule is used as an example since it is relatively simple because the number of electrons is only 2 in total. Each (valence) electron of the hydrogen atoms is hosted in a 1s-orbital. When the two 1s-orbitals approach each other, two new molecular orbitals are formed; one bond orbital and one anti-bond orbital which is sketched in Figure 2- 6. Note that the electrons are sketched as arrows pointing either upwards or down (either $+\frac{1}{2}$ or $-\frac{1}{2}$ as spin quantum number).

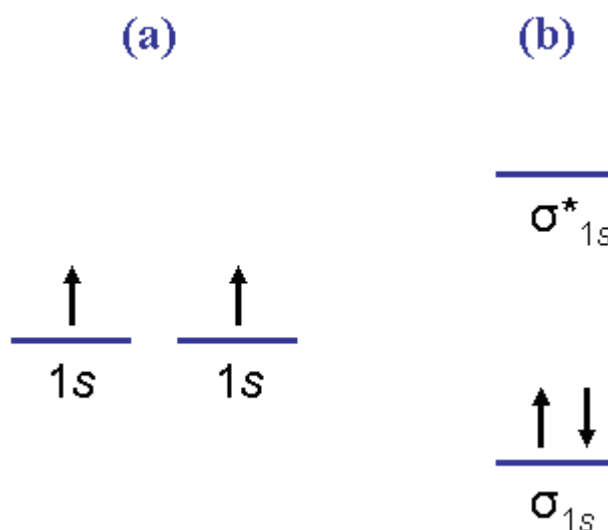
**Figure 2- 6: Molecular orbitals in the hydrogen molecule**

(a) The two atomic orbitals (1s) when the atoms appear in single (b) The two atomic orbitals “melt” together and two molecular orbitals are created. One of the molecular orbitals is a bond orbital (σ_{1s}) and one is an anti-bond orbital (σ^*_{1s}).

Since the molecular bond orbital (σ_{1s}) is lower in energy level at the two individual atomic orbitals, the two valence electrons rather prefer so stay in the bond orbital. The energy level of the anti-bond orbital (σ^*_{1s}) is higher than that of the atomic orbitals and thus the valence electrons will no be hosted in this orbital.

So because the total energy can be minimized it is beneficial for the two hydrogen atoms to form a hydrogen molecule.

A covalent bond can be assigned with a so-called *bond order* according to the following equation:

$$\text{Bond order} = \frac{(\text{electrons in bond orbitals}) - (\text{electrons in anti - bond orbitals})}{2} \quad (2- 1)$$

The bond order is related to the bond energy. The larger bond orders the larger bond energy. In the case with the hydrogen molecule (Figure 2- 6) there are two electrons in the bond orbital σ_{1s} and zero electrons in the anti-bond orbital σ^*_{1s} . This gives the covalent H-H bond a bond order of 1 and it corresponds to a *single bond*. If the bond order would have been 2 (corresponding to a *double bond*) the bond energy would have been larger. In the following example we find out why two helium atoms do not join and form a helium molecule (He_2).

Example 2- E: Molecular orbitals in a “helium molecule”

A helium atom has both of its valence electrons in the 1s-orbital. When two helium atoms approach each other two molecular orbital can be formed which is sketched in Figure 2- 7.

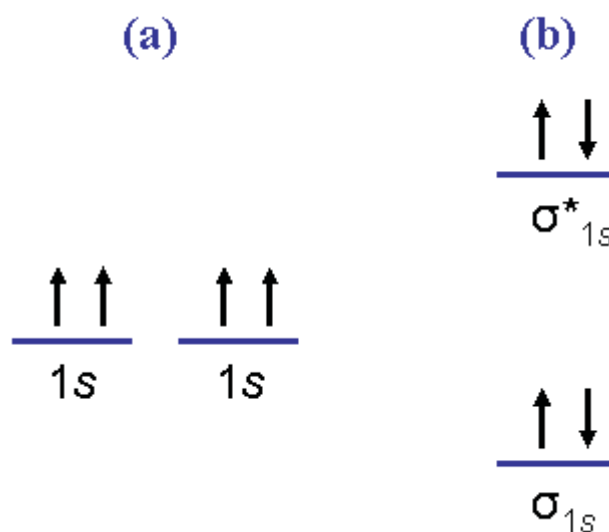

Figure 2- 7: Molecular orbitals in a “helium molecule”

(a) The two atomic orbitals (1s) when the atoms appear in single. (b) The two atomic orbitals “melt” together and two new molecular orbitals are created. One of the molecular orbitals is a bond orbital (σ_{1s}) and one is an anti-bond orbital (σ^*_{1s}) but no chemical bond is created since the bond order is zero.

Since only two electrons can be hosted in each orbital, the total number of four valence electrons has to be distributed into two electrons in the bond orbital and two electrons into the anti-bond orbital. The bond order is then calculated by use of equation (2- 1):

$$\text{Bond order} = \frac{2 - 2}{2} = 0$$

This situation gives a bond order of zero according to equation (2- 1) and thus it is not beneficial for two helium atoms to join and form a covalent bond. This is hence the answer to the question about why two hydrogen atoms form a molecule while two helium atoms do not.

When talking about molecular orbital theory you have to be aware of the following:

- It is only the atomic orbitals of the valence electrons that are transformed into molecular orbitals.
- The total number of valence electron atomic orbitals equals the number of molecular orbitals.
- For two identical atoms: Molecular orbitals are denoted σ (bond orbital) and σ^* (anti-bond orbital) respectively subscripted by the name of the former atomic orbitals (see for example Figure 2- 6 and Figure 2- 7)

It can be quite a difficult task to find out which molecular orbitals that are formed and which energy levels these orbital have when we are looking at other atoms than hydrogen and helium; especially when we are dealing with different atoms with different numbers of valence electrons in different types of atomic orbitals. In this book we are not going to go more into molecular orbital theory. This was just a brief introduction to a model which can explain why some atoms form molecules and why other atoms do not. It is all a matter of bond orders. If the bond order is zero there is no benefit in terms of energy of forming a molecule. If the bond order is larger than zero it is beneficial in terms of energy to form a molecule.

Please click the advert

WHAT'S MISSING IN THIS EQUATION?

You could be one of our future talents

MAERSK INTERNATIONAL TECHNOLOGY & SCIENCE PROGRAMME

Are you about to graduate as an **engineer** or **geoscientist**? Or have you already graduated?
If so, there may be an exciting future for you with A.P. Moller - Maersk.



MAERSK

www.maersk.com/mitas

Molecular orbital theory can also be used to explain other phenomena such as diamagnetism and paramagnetism. According to Hund's rule (see section 1.2.2 *Electron configuration*) the electrons would rather prefer to stay unpaired in the atomic orbitals if this is possible. This is also the case in the molecular orbitals. If it is possible for the electrons to stay unpaired in the molecular orbitals they will do so and the molecules will appear paramagnetic. This is for example the case with a oxygen molecule (O_2) which has two unpaired electrons in two of the anti-bond orbitals.

2.2.3 Lewis structure

In section 2.2.2 *Molecular orbital theory* we saw that bond orders can be explained by molecular orbital theory. In this section we are going to look at an alternative theory that can explain bond orders as well as helping us to determine the position of the atoms inside molecules relative to each other. We are going to spend some time on the Lewis theory which is named after the American scientist G. N. Lewis. According to Lewis' theory the atoms have one goal when they join and form molecules:

The goal of the atoms during the formation of molecules is to get the valence electron orbital filled with electron (Lewis' theory)

For a while let us forget all about molecular orbital theory and think in terms of atomic orbitals. When atoms join and form molecules they will seek to get their valence electron orbitals filled with electrons according to the theory of G.N. Lewis. This implies that

- hydrogen atoms want to be surrounded by 2 electrons so that the valence electron atomic orbital $1s$ will be filled with electrons.
- Elements in the 2nd period want to be surrounded by 8 electrons so that the valence electron atomic orbitals ($2s$ and $3 \times 2p$) will be filled with electrons. This is referred to as the *octet rule* since “octa” means “eight”.

The atoms can obtain this by sharing electrons. The elements in the 3rd period and downwards have the ability of being surrounded by more than eight electrons since their empty 3d-atomic orbitals can assist in hosting the shared electron pairs. When you want to determine the bond order in a molecule, the molecule with all its atoms can be written in so-called *dot form*. This is done by writing the letter symbol of the atom surrounded by a number of dots corresponding to the number of valence electrons for that particular atom. The atoms in dot forms can then be combined into *Lewis structures* for different molecules.

Example 2- F: Atoms in “dot notation”

In Figure 2- 8 different atoms are represented in *electron dot form*. First the number of valence electrons is determined from the position in the periodic table. Then a number of dots are placed around the letter symbol for the atom corresponding to the number of valence electrons. We have to notice that it is *only* the valence electrons that are represented by dots.

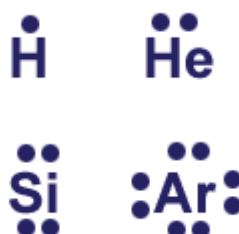

Figure 2- 8: Atoms in “dot notation”

The hydrogen atom has one valence electron, the helium atom has two valence electrons, the silicon atom has four valence electrons, and the argon atom has eight valence electrons (the octet rule is fulfilled for argon).

The number of dots corresponds to the number of valence electrons. When the atom is surrounded by eight electrons the octet rule is satisfied. The electrons are often placed in pairs. Such an electron pair is called a *lone pair*.

By use of Lewis' theory and atoms in "electron dot forms" we are prepared to look at how atoms are arranged inside the molecules relative to each other. When the so-called *Lewis structure* of a molecule or composite ion is to be written on a piece of paper, the following guidelines have to be followed:

- 1) Determine the total number of valence electrons for the molecule/composite ion. This is done by summing up the number of valence electrons for the individual atoms (plus the "extra ionic charge" if we are dealing with a composite ion). Thus the number of "dots" of the individual atoms has to be counted. (2- 2)
- 2) Connect all atoms by using one electron pair.
- 3) Arrange the remaining valence electrons such that hydrogen atoms are surrounded by 2 atoms and that the octet rule is satisfied for the elements from the 2nd period. It can be necessary to let more than one electron pair be a part of chemical bond (creation of double or triple bonds).

In the following examples we are going to write down the Lewis structures for different molecules and composite ions by using these three steps given in (2- 2).

Example 2- G: The ammonia molecule in Lewis structure

An ammonia molecule consists of three hydrogen atoms and one nitrogen atom. How are these atoms placed relative to each other? In order to answer this question we will write down the Lewis structure according to the guidelines given in (2- 2).

- 1) Number of valence electrons = 5 (from nitrogen) + 3×1 (from hydrogen) = 8
- 2) Use one electron pair to connect each N-H atom pair
- 3) The last $8 - 3 \times 2 = 2$ electrons are arranged so that the octet rule is satisfied



www.job.oticon.dk

oticon
PEOPLE FIRST

These three steps are sketched in Figure 2- 9.

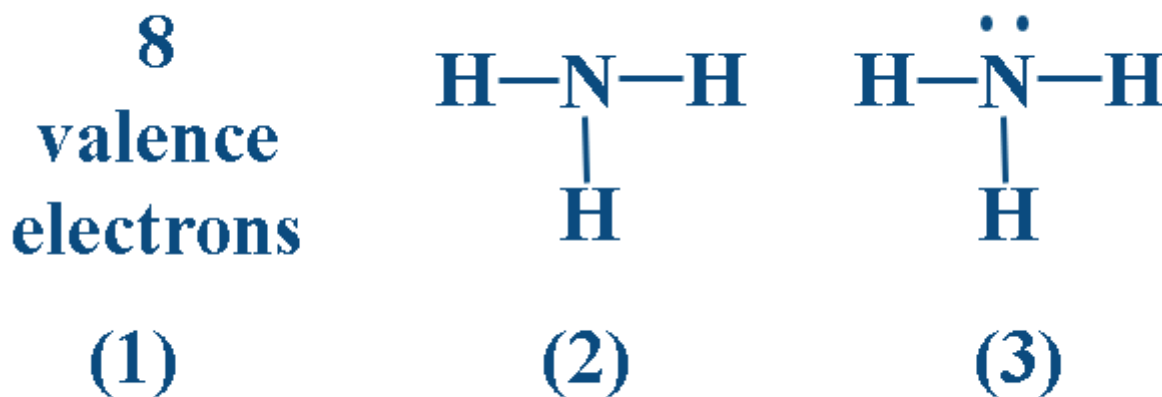

Figure 2- 9: Lewis structure for the ammonia molecule

The three steps in writing the Lewis structure. The octet rule has to be satisfied for all the atoms in the molecule. Thus the lone pair is placed on the nitrogen atom.

The only way in which the octet rule can be satisfied is by placing the atoms and electrons as sketched in the figure. Moreover it is seen that the three N-H bonds consist of single electron pairs which corresponds to single bonds. The Lewis structure has thus told us that in an ammonia molecule the nitrogen atom is placed in the centre connected to each of the three hydrogen atoms by single bonds. Furthermore a lone pair is “attached” to the nitrogen atom. We now know something about the internal arrangement of atoms and lone pairs inside the molecule but we do not know about the actual geometry of the molecule.

In an ammonia molecule all bonds are single bonds. Sometime in order to satisfy the octet rule when Lewis structures are to be written down for certain molecules it is necessary to let more than one electron pair go into a bond. This leads to a higher bond order than 1.

Example 2- H: The carbon dioxide molecule in Lewis structure

A molecule of carbon dioxide consists of a carbon atom and two oxygen atoms. We wish to write down the Lewis structure for this molecule in order to investigate the bond orders of the bonds inside the molecule. Thus we again follow the guidelines given in (2- 2).

- 1) Number of valence electrons = 4 (from carbon) + 2 × 6 (from oxygen) = 16
- 2) Use one electron pair to connect each C-O bond
- 3) Arrange the last 16 - 2×2 = 12 electrons so that the octet rule is satisfied for all three atoms

The octet rule can only be satisfied if each C-O bond is made of two electron pairs which equals to four electrons. This corresponds to double bonds. The three steps are sketched in Figure 2- 10.

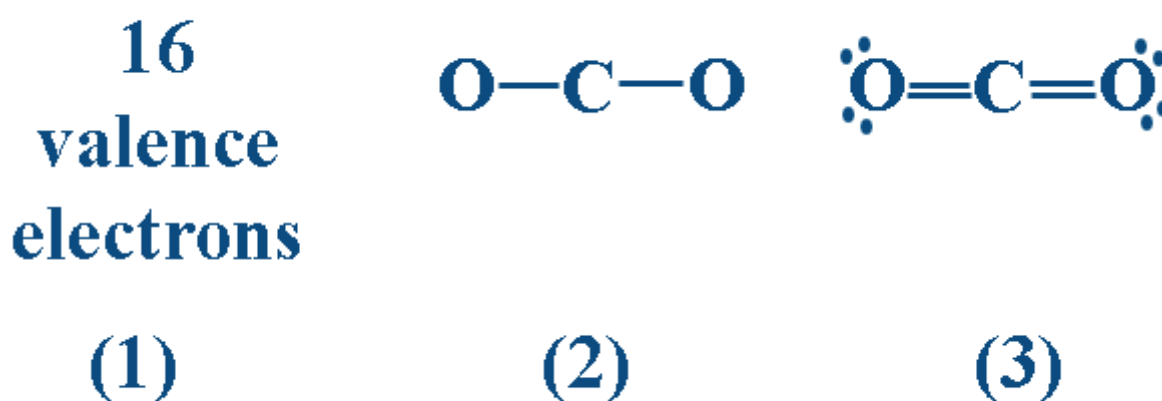

Figure 2- 10: Lewis structure for the carbon dioxide molecule

The three steps in writing the Lewis structure. The octet rule has to be satisfied for all the atoms in the molecule. Therefore it is necessary with double bonds between the carbon atom and the oxygen atoms.

That way the Lewis structure for carbon dioxide has now told us that in this molecule the carbon atom is placed in the centre. Each oxygen atom is double bonded to the carbon atom and two lone pairs are “attached” to each oxygen atom. But from the Lewis structure we know nothing about the actual molecular geometry.

We know that hydrogen (from the 1st period) wants to be surrounded by *two* electrons and that elements from the 2nd period want to satisfy the octet rule by being surrounded by *eight* electrons. The elements from the 3rd period and downwards can however be surrounded by more than eight electrons because their empty d-orbitals are able to assist in hosting more than the eight electrons.

Example 2- 1: The sulphur hexafluoride molecule in Lewis structure

A SF_6 molecule consists of one sulphur atom and six fluorine atoms. We wish to write down the Lewis structure for this molecule in order to know something about the internal atomic arrangement and the positions of the lone pairs in this molecule. Thus the 3-step procedure given by (2- 2) is used again:

- 1) Number of valence electrons = 6 (from sulphur) + 6×7 (from fluorine) = 48
- 2) Use one electron pair pr. S-F bond. Since sulphur is from the 3rd period it can be surrounded by more than eight electrons.
- 3) The remaining $48 - 6 \times 2 = 36$ electrons are arranged so that the octet rule is satisfied for all fluorine atoms.

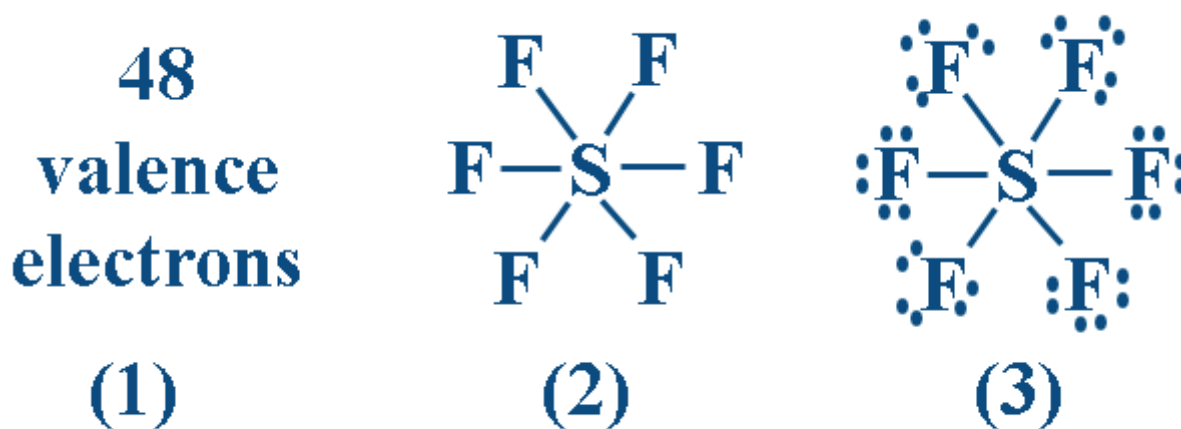

Figure 2- 11: Lewis structure for the sulphur hexafluoride molecule

The three steps in writing the Lewis structure. The octet rule has to be satisfied for all the atoms in the molecule. Sulphur from the 3rd period has the ability to be surrounded by more than eight electrons pairs by using its empty 3d-orbitals.

From the Lewis structure we now know that the sulphur atom is placed in the centre and is bonded to the six fluorine atoms by single bonds. Furthermore we know that each fluorine atom is surrounded by three lone pairs. But from the Lewis structure we know nothing about the actual geometry of the molecule.

The 3-step procedure given by (2- 2) can also be applied for composite ions such as sulphate, nitrate, cyanide etc. We are going to look more into that in the following example where the Lewis structure for nitrate will be given. During this procedure we will run into the concept of *resonance structures*.

Example 2- J: Nitrat in Lewis structure

Nitrate (NO_3^-) consists of a nitrogen atom, three oxygen atoms plus one negative charge. We wish to write down the Lewis structure for this composite ion. Thus we use the three steps given by (2- 2).

- 1) Number of valence electrons = 5 (from nitrogen) + 3×6 (from oxygen) + 1 (one extra negative charge) = 24
- 2) Use one electron pair pr. N-O bond.
- 3) The remaining $24 - 3 \times 2 = 18$ electrons are arranged so that the octet rule will be satisfied for all atoms. It is necessary to let one of the N-O bonds be a double bond. Experiments have however proved that the bond energy for the three N-O bonds is equal which indicated that all three N-O bonds are similar. Thus we consider the Lewis structure for nitrate to be a mixture of the three structures given in Figure 2- 12(3). These three possible Lewis structures given in Figure 2- 12(3) are called *resonance structures*. Alternatively the bonds can be sketched by one full line and one dotted line to show the case of resonance.

Please click the advert



CHALLENGE YOURSELF

WWW.STUDYINSWEDEN.SE

Si.
Swedish Institute

Today's job market values ambitious, innovative, perceptive team players. Swedish universities foster these qualities through a forward-thinking culture where you're close to the latest ideas and global trends.

Whatever your career goals may be, studying in Sweden will give you valuable skills and a competitive advantage for your future. www.studyinsweden.se

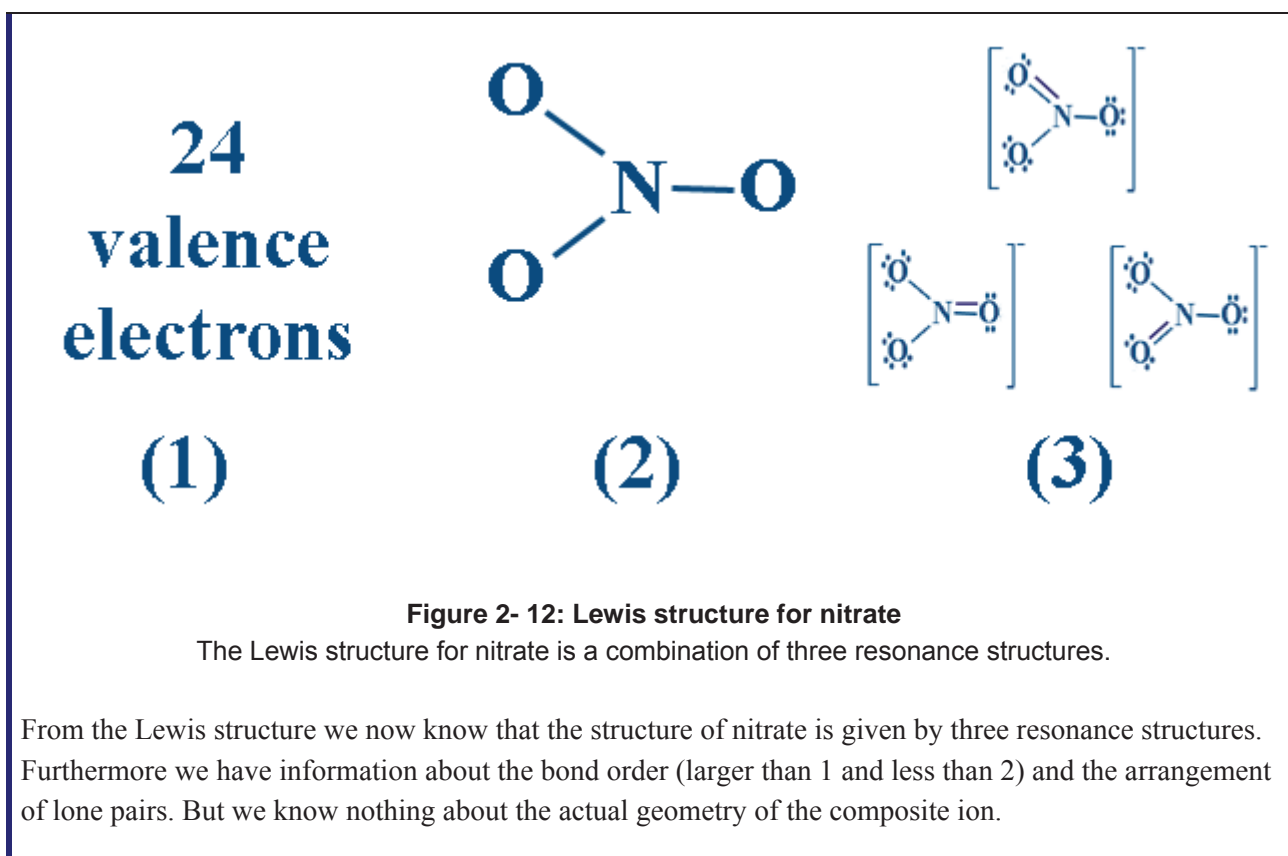

In the examples we have been looking at until now it has been pretty clear which atom would be the central atom. For some molecules or composite ions, however, it is not always so obvious which atom is the central atom. In order to be able to write down the Lewis structure for such a molecule or composite ion, we have to introduce the concept of *formal charge*. The formal charge of an atom in a molecule or composite ion has the following definition:

$$\left. \begin{array}{l} \text{Formal charge} \\ \text{of an atom} \end{array} \right\} = (\text{number of surrounding electrons}) - (\text{number of valence electrons}) \quad (2-3)$$

The number of surrounding electrons is determined by dividing the number of bond electrons equally between the two atoms among which the chemical bond is located. Secondly you count the number electrons surrounding the atom on the Lewis structure. The number of valence electrons for an atom is known from its electron configuration and thus from its position in the periodic table. In the following example we are going to write down the Lewis structure for a nitrous oxide molecule and from the concept of formal charge we are going to evaluate which of more possible Lewis structures are the most realistic.

It is seen in Figure 2- 13b that the formal charge is determined as the difference between number of surrounding electrons and valence electrons for a particular atom. A “half” single bond gives 1 surrounding electron pr. atom, a “half” double bond gives 2 surrounding electrons pr. atom, and a “half” triple bond gives 3 surrounding electrons pr. atom. However, from the Lewis structure we know nothing about the actual geometry of the molecule.

In the Lewis structure we have a useful tool that can predict internal atomic arrangement and positions of lone pairs inside molecules and composite ions. Furthermore we can have valuable information about the bond orders (whether we are dealing with single, double, or triple bonds) and we can get information about possible resonance structures. The concept of formal charge could also be useful in judging which of more possible Lewis structures are the most realistic.

BUT the Lewis structures tell us nothing about the actual geometry of the molecules or composite ions.

- Why is a carbon dioxide molecule linear?
- Why is a water molecule V-shaped?
- Why do ammonia molecules attain trigonal pyramid shape?

The answers to these questions can be found in the VSEPR theory which is the topic of the next section.

Please click the advert

Always aiming for higher ground. Just another day at the office for a Tiger.

Join the Accenture High Performance Business Forum

On Thursday, April 23rd, Accenture invites top students to the High Performance Business Forum where you can learn how leading Danish companies are using the current economic downturn to gain competitive advantages. You will meet two of Accenture's global senior executives as they present new original research and illustrate how technology can help forward thinking companies cope with the downturn.

Visit student.accentureforum.dk to see the program and register

Visit student.accentureforum.dk

• Consulting • Technology • Outsourcing

High performance. Delivered.

© 2009 Accenture. All rights reserved.

2.2.4 VSEPR theory

VSEPR stands for *valence shell electron pair repulsion*. VSEPR theory can be used to predict actual geometries of molecules and composite ions. To be more precise it is a matter of determining bond directions and angles relative to the central atom in a molecule or composite ion. VSEPR theory can very shortly be formulated as follows:

The electron groups surrounding the central atom in a molecule or composite ion will be located as far apart from each other as possible.

This statement or definition is based on an uncountable number of experimental studies of a numerous number of different molecules and composite ions during the times. A relevant question is therefore “what is an electron group then? There are more answers to this. An electron group can be:

- A single bond (one electron pair consisting of 2 electrons)
 - A double bond (two electron pairs consisting of 4 electrons)
 - A triple bond (three electron pairs consisting of 6 electrons)
 - A lone pair (one “free” electron pair consisting of 2 electrons)
 - A single electron (a radical)
- } different types of electron groups

When we are to determine how many electron groups that surround an atom, the Lewis structure can be of great help (see the previous section 2.2.3 *Lewis structure*). From the Lewis structure of a given molecule you can simply count how many bonds and lone pairs that surround an atom. That way you have the number of electron groups. The VSEPR theory tells us that these electron groups will be located as far apart as possible. In the following example we will use the VSEPR theory to predict the molecular geometries of a water molecule and a carbon dioxide molecule. That way we will discover why a carbon dioxide molecule is linear and why a water molecule is V-shaped.

Example 2- L: CO₂ and H₂O, VSEPR theory

We wish to predict the molecular geometries of a water molecule and a carbon dioxide molecule, respectively. The VSEPR theory is our tool to solve this job and it tells us that the electron groups surrounding the central atom will be placed as far apart as possible.

The first step is to write the Lewis structure for the two molecules in order to be able to just count the number of electron groups surrounding the central atom. This is done in Figure 2- 14.



Figure 2- 14: Electron groups in H₂O and CO₂

From the Lewis structure the number of electron groups surrounding the central atoms is counted. The oxygen atoms in the water molecule are surrounded by four electron groups (two lone pairs and two single bonds). The carbon atom in the carbon dioxide molecule is surrounded by two electron groups (two double bonds).

The carbon atom in CO₂ is surrounded by two electron groups (two double bonds) whereas the oxygen atom in H₂O is surrounded by four electron groups (two single bonds and two lone pairs). According to the VSEPR theory these electron groups will be placed as far apart as possible. When there are only two electron groups these will be as far apart when they are placed 180° apart on a straight line with the central atom in the middle. Thus the atoms will be placed on a straight line which gives the linear structure of the carbon dioxide molecule. The four electron groups in the water molecule are placed as far apart as possible when they are placed in a so-called tetrahedron with angles of 109.5° around the central atom. That way the two hydrogen atoms will be placed on two of the positions of the tetrahedron while the two lone pairs will occupy the two other positions. Thus the H-O-H bonds do not give a straight line but rather a V-shape. The angle of the H-O-H bonds is however slightly smaller than the tetrahedral angles of 109.5°. The H-O-H angle is actually just 104°. Thus an addition to the VSEPR theory is necessary in order to explain this “smaller” angle:

Lone pairs occupy a larger volume around the central atom than bond electron pairs. Thus lone pairs will “press” the atomic bond together.

This means that the two lone pairs around the oxygen atom in the water molecule will “press” the two single bonds together and therefore the H-O-H angle is smaller than the tetrahedral angle of 109.5°. The two geometries are sketched in Figure 2- 15.

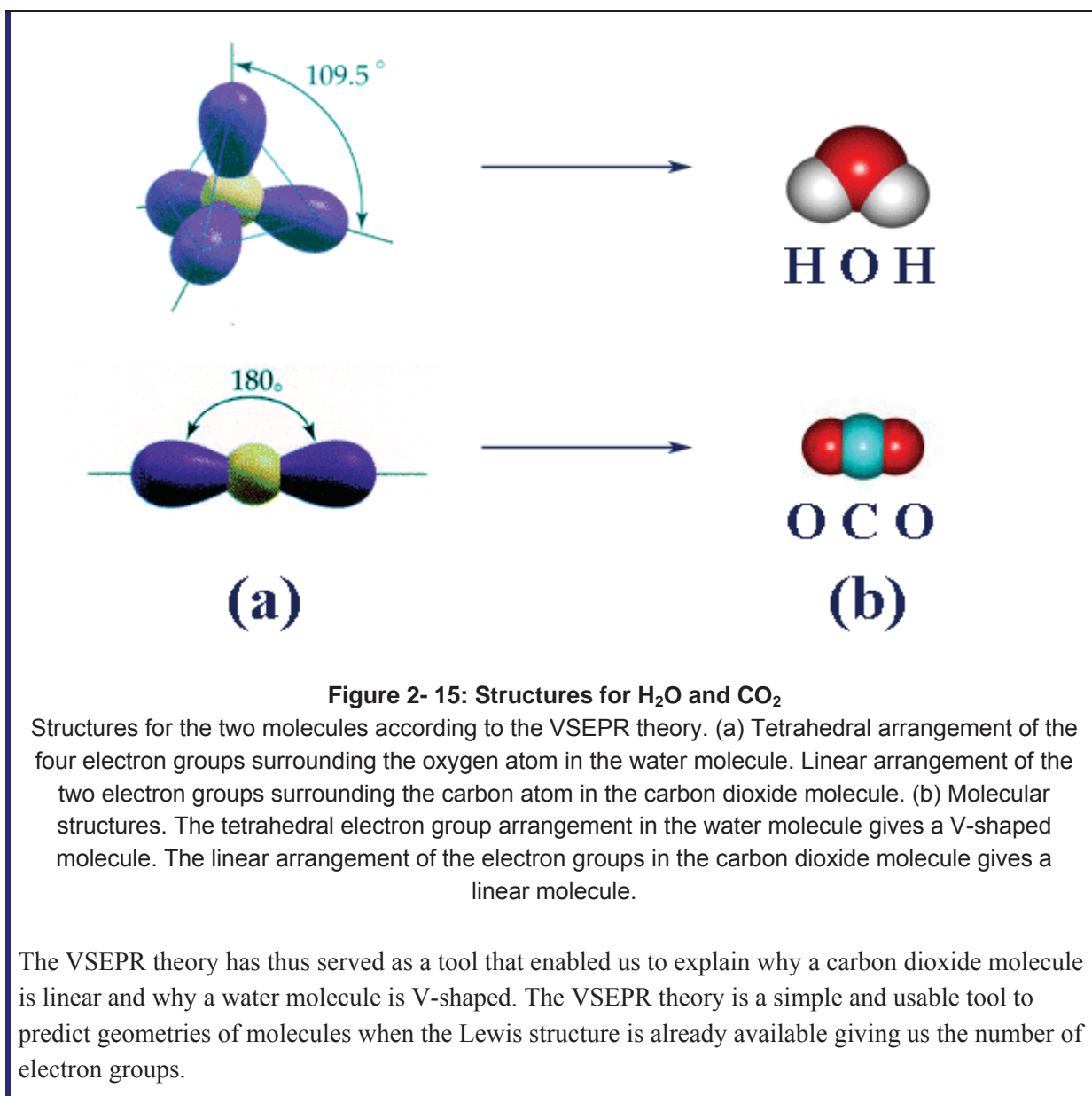

It is (as mentioned earlier) the number of electron groups surrounding the central atom that determines the arrangement and geometry around the central atom. In Example 2- L we just saw that lone pairs occupy more space than bond electrons. For lone pairs the following rules apply:

- Lone pairs occupy more space than bond electron groups
- Lone pairs will be placed as far apart from other lone pairs as possible
- Lone pairs will be placed as far apart from bond electron groups as possible

These guidelines can be used to predict the arrangement of bond electron groups and lone pairs relative to each other around the central atom when the total number of electron groups is known and when the number of lone pairs is known. In Table 2- 1 you can see how the geometry of a molecule depends on the number of electron groups and how many of these groups that are lone pairs.

Table 2- 1: Geometries of molecules and composite ions

The geometry depends on the number of electron groups surrounding the central atom of the molecule or composite ions and how many of these electron groups that are lone pairs.

Electron groups	Electron group arrangement	Bond electron pairs	Lone pairs	Geometry of molecule or composite ion	Example
2	Linear	2	0	Linear	CO ₂
3	Trigonal planar	3	0	Trigonal planar	NO ₃ ⁻
		2	1	V-shape	NO ₂ ⁻
4	Tetrahedral	4	0	Tetrahedral	CH ₄
		3	1	Trigonal pyramidal	PH ₃
		2	2	V-shape	H ₂ O
5	Trigonal bipyramidal	5	0	Trigonal bipyramidal	PCl ₅
		4	1	Seesaw [*]	SF ₄
		3	2	T-shaped [*]	BrF ₃
		2	3	Linear	XeF ₂
6	Octahedral	6	0	Octahedral	SF ₆
		5	1	Square pyramidal	IF ₅
		4	2	Square planar	XeF ₄

*These rather special geometries are not explained in this book. Educational textbooks describing orbital hybridization theory can explain why these specific geometries are observed for the particular molecules for that particular number of bond electron groups and lone pairs.

By use of VSEPR theory, in which the Lewis structures helped us determining the number of electron groups, we are now able to predict actual geometry of molecules and composite ions. However from the VSEPR theory we know nothing about the chemical bond itself. Where are the bond electrons actually located? Or more specific: In which types of orbitals are the bond electrons hosted? The answer to this can be found in the orbital hybridization theory which is the topic of the next section.

2.2.5 Orbital hybridization

In the previous section (2.2.4 VSEPR theory) we saw that the number of electron groups (bond electron pairs and lone pairs) around the central atom is determining the geometry of the molecule or composite ion. We have also been looking at the geometry of the atomic orbitals in the section 1.1.7 *Orbital configuration*. However, the orientations of the atomic orbitals in space do not fit the directions predicted by the VSEPR theory according to Table 2- 1. For this reason other orbitals than the atomic orbitals must be present in the molecules and composite ions in order to “give” the right bond directions according to the VSEPR theory. These orbitals are a type of molecular orbitals (also mentioned in section 2.2.2 *Molecular orbital theory*) which are called *hybrid orbitals*. These hybrid orbitals thus host the valence electrons which constitutes the chemical bond between the atoms.

When atoms join and form molecules by creating covalent bonds, the atomic orbitals do not have the right directions and orientations which mean that they can not host the bond electrons. According to the theory of orbital hybridization, the atoms solve this problem by making existing atomic orbitals into “new” hybrid orbitals. This is the same principle as for the molecular orbitals. These hybrid orbitals (which are molecular orbitals) then have the right orientation in space according the VSEPR theory. Thus the bond electrons and the lone pairs (the electron groups) surrounding the central atom can be placed as far apart as possible. The formation of the hybrid orbitals will be explained and sketched through the following examples.

Please click the advert



it's an **interesting** world

Get under the skin of it.

Graduate opportunities
Cheltenham | £24,945 + benefits

One of the UK's intelligence services, GCHQ's role is two-fold: to gather and analyse intelligence which helps shape Britain's response to global events, and, to provide technical advice for the protection of Government communication and information systems. In doing so, our specialists – in IT, internet, engineering, languages, information assurance, mathematics and intelligence – get well beneath the surface of global affairs. If you thought the world was an interesting place, you really ought to explore our world of work.

www.careersinbritishintelligence.co.uk

Applicants must be British citizens. GCHQ values diversity and welcomes applicants from all sections of the community. We want our workforce to reflect the diversity of our work.



Example 2- M: NH₃ molecule, sp³-hybridization

Let us start by looking at a molecule of ammonia. First the Lewis structure of the molecule has already been determined (see Figure 2- 16a). The central nitrogen atom is surrounded by four electron groups (three single bonds and a lone pair). The question is in which orbitals these electron groups are hosted? The spherical atomic s-orbital and the three atomic p-orbitals are not arranged around the nitrogen atom in a tetrahedron as the VSEPR theory requires. The nitrogen atom solves this problem by transforming the four atomic orbitals into four “new” identical hybrid orbitals. These four orbitals are called *sp³* hybrid orbitals and they are arranged in a tetrahedral manner around the nitrogen atom.

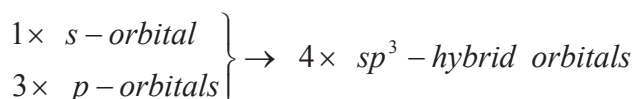

The name *sp³* indicates that we are talking about a transformation of *one* s-orbital and *three* p-orbitals. The new four hybrid orbitals are then used to host the four electron groups surrounding the nitrogen atom in an ammonia molecule which is sketched in Figure 2- 16b.

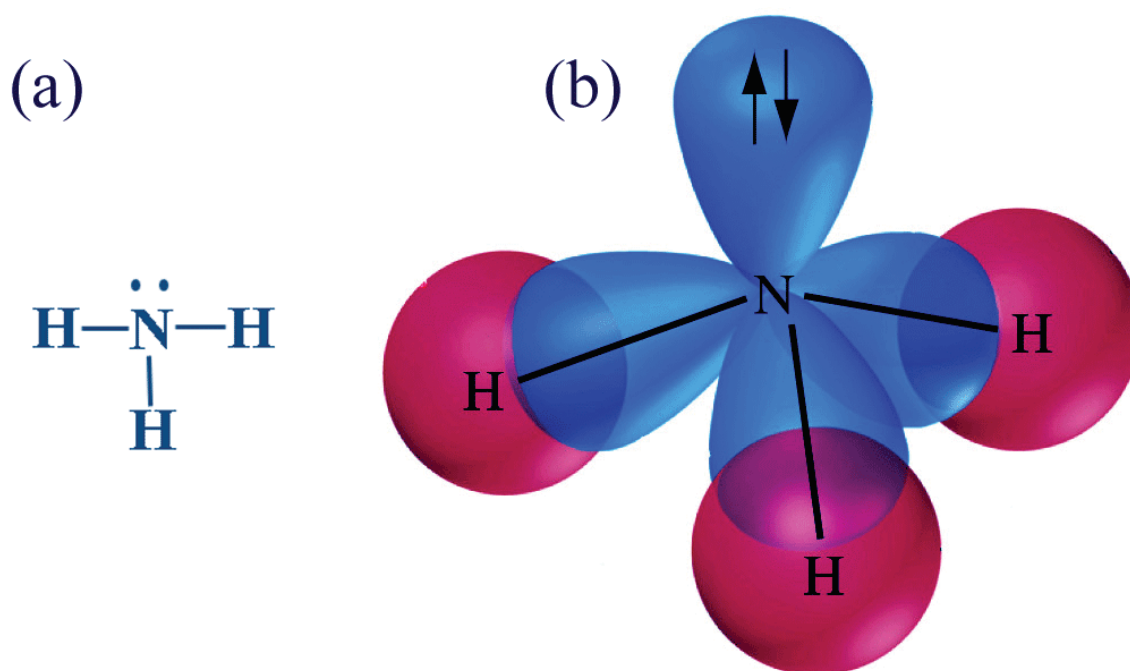

Figure 2- 16: sp³-hybridization in NH₃

(a) Lewis structure for an ammonia molecule. (b) The central nitrogen atom is *sp³* hybridized. The four *sp³* orbitals are blue on the figure. The 1s-orbitals of the three hydrogen atoms are red on the figure. The lone pair (marked with two arrows) occupies more space than the bond electron pairs between the nitrogen atom and the three hydrogen atoms. Thus the lone pair “pushes” the angles between the N and H atoms so that these angles become less than the tetrahedral angle of 109.5°.

By using the hybrid orbitals to host the bond electron pairs and the lone pair, the tetrahedral structure predicted by the VSEPR theory is obtained. You can see an overlap between the s-orbitals of the hydrogen atoms and the sp^3 orbitals of the nitrogen atom and these overlaps constitute the single bonds. The lone pair occupies more space than the three bond electron pairs. This means that the lone pair “presses” the three bonds together so that the angles are only 107° rather than the tetrahedral angle of 109.5° .

Since only two electrons can be hosted in one orbital, the hybrid orbitals can also host one bond electron pair which correspond to the number of electrons in a single bond. Such a single bond is called an σ -bond which we also saw in the section 2.2.2 *Molecular orbital theory*. If we are dealing with a double bond (consisting of four electrons) one hybrid orbital is not enough for such a bond. In that case, already existing atomic p -orbitals are used for the creation of so-called π -bonds which together with σ -bonds constitute double bonds (and triple bonds). A molecule of ethylene can be used as an example which we are going to look at now.

Please click the advert

CHALLENGE YOURSELF

WWW.STUDYINSWEDEN.SE

Si.
Swedish Institute

Today's job market values ambitious, innovative, perceptive team players. Swedish universities foster these qualities through a forward-thinking culture where you're close to the latest ideas and global trends.

Whatever your career goals may be, studying in Sweden will give you valuable skills and a competitive advantage for your future. www.studyinsweden.se

Example 2- N: C₂H₄ molecule, sp²-hybridization

It is seen from the Lewis structure of C₂H₄ (Figure 2- 17a) that the two central carbon atoms each are surrounded by three electron groups (1 double bond and 2 single bonds). Three such electron groups surrounding the central atom results in a trigonal planar arrangement according to Table 2- 1 (from the VSEPR theory). Thus there is a need for three identical orbital with such a trigonal planar arrangement to host the electron groups. Each carbon atom then transforms *one* s-orbital and *two* p-orbitals into three identical sp²-hybrid orbitals. As the name sp² indicated, they are composed of *one* s-orbital and *two* p-orbitals.

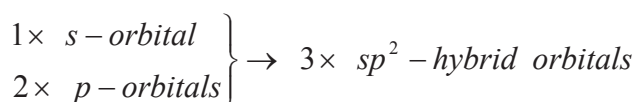

Hence *one* atomic p-orbital remains unchanged in each carbon atom. The double bond is composed of the overlap between two sp² orbitals (a σ-bond) and a π-bond that is formed in the space between the two remaining atomic p-orbitals of the carbon atoms. This is sketched in Figure 2- 17b.

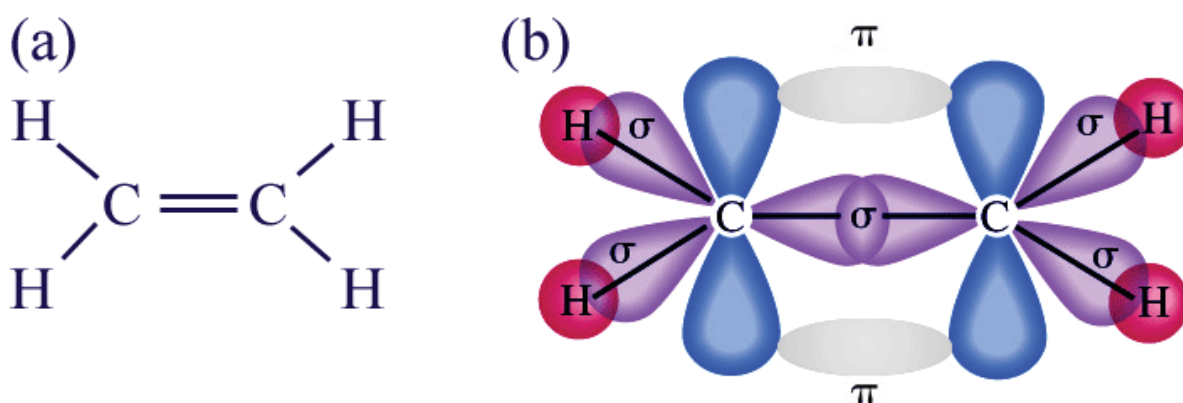

Figure 2- 17: sp²-hybridization in C₂H₄

(a) Lewis structure of an ethylene molecule. (b) Each carbon atom is sp² hybridized (the 2×3 sp² orbitals are purple on the figure). The double bond consists of an σ-bond (overlap of the two sp² orbitals) and a π-bond in the space between the two p-atomic orbitals. The two p-orbital are blue on the figure while the π-bond is grey on the figure. The bonds to the hydrogen atoms are σ-bonds.

From the figure it is seen that rotation around the C=C double bond is not possible because the π-bond “locks” a possibility of rotation. Thus double bonds are far less flexible compared to single bonds which only consist of σ-bonds.

In the previous example we have seen how a double bond consists of *one* σ-bond and *one* π-bond. In the case with the linear carbon dioxide molecule, the central carbon atom is double bonded to each of the two oxygen atoms which we saw in Example 2- H. How is that possible? The answer is given in the following example.

Example 2- O: CO₂ molecule, *sp*-hybridization

From the Lewis structure of the carbon dioxide molecule (Figure 2- 18a) it is seen that the carbon atom is surrounded by two electron groups (two double bonds). Two electron groups mean that there is a need for two identical orbitals 180° apart according to the VSEPR theory and Table 2- 1. The carbon atom solves this problem by forming two identical so-called *sp*-hybrid orbital. As the name *sp* indicated these orbitals are made from *one* *s*-orbital and *one* *p*-orbital.

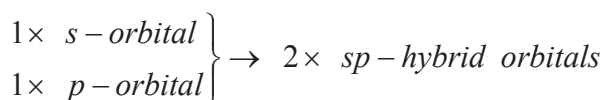

Hence *two* of the atomic *p*-orbitals in the carbon atom remain unchanged. From the Lewis structure it is also seen that each oxygen atom is surrounded by three electron groups (2 lone pairs and 1 double bond). In Example 2- N we saw that three electron groups around an atom results in *sp*² hybridization. Thus the carbon atom is *sp*-hybridized and the two oxygen atoms are each *sp*² hybridized. This is sketched in Figure 2- 18b.

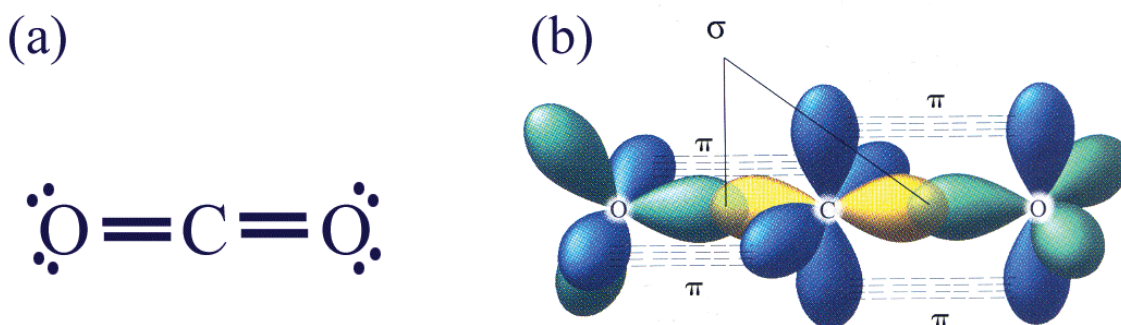

Figure 2- 18: *sp*-hybridization in CO₂

(a) Lewis structure of a carbon dioxide molecule. (b) The carbon atom is *sp*-hybridized (two yellow *sp*-orbitals) while the two oxygen atoms are *sp*² hybridized (2×3 green *sp*²-orbitals). The double bonds each consist of an σ -bond (overlap of a *sp*-orbital and a *sp*²-orbital) and a π -bond in the space between one *p*-orbital from the carbon atom and one from the oxygen atom. The *p*-orbitals are blue on the figure while the π -bonds are indicated with dotted lines.

Again we see that in double bonds we have σ -bonds in the overlap between hybrid orbitals and π -bonds in the space between atomic *p*-orbitals. Thus in the case of carbon dioxide the two π -bonds are oriented 90° relative to each other.

If the central atom is from the 3rd period and downwards we have seen (in the section 2.2.3 *Lewis structure*) that it is possible for the central atom to be surrounded by more than four electron groups (eight electrons). In Table 2- 1 it is seen that when the central atom is surrounded by five electron groups these will be arranged as a trigonal bipyramide. This required five identical orbitals with such an arrangement and orientation. This is achieved if the central atom transforms five atomic orbitals

(one *s*-orbital, three *p*-orbitals and one *d*-orbital) into five identical so-called dsp^3 -hybrid orbitals. Again the name indicates that these hybrid orbitals are made from one *s*-orbital, three *p*-orbitals and one *d*-orbital. In a similar manner we know that when the central atom is surrounded by six electron groups these will be arranged like an octahedron around the central atom. This requires six identically orbitals with such an arrangement and therefore the central atom transforms one *s*-orbital, three *p*-orbitals and two *d*-orbitals into six identically d^2sp^3 -hybrid orbitals which are arranged around the central atom like an octahedron.

Table 2- 2: Hybrid orbitals

The number of electron groups surrounding the central atom determines which types of hybridization orbital that surround the central atom and thus the orbital geometry around the central atom.

Electron groups	Hybridization	Atomic Orbitals			Geometry around central atom
		s	p	d	
2	sp	1	1	0	Linear
3	sp^2	1	2	0	Trigonal planar
4	sp^3	1	3	0	Tetrahedral
5	dsp^3	1	3	1	Trigonal bipyramide
6	d^2sp^3	1	3	2	Octahedral

Please click the advert

Brain power

By 2020, wind could provide one-tenth of our planet's electricity needs. Already today, SKF's innovative know-how is crucial to running a large proportion of the world's wind turbines.

Up to 25 % of the generating costs relate to maintenance. These can be reduced dramatically thanks to our systems for on-line condition monitoring and automatic lubrication. We help make it more economical to create cleaner, cheaper energy out of thin air.

By sharing our experience, expertise, and creativity, industries can boost performance beyond expectations. Therefore we need the best employees who can meet this challenge!

The Power of Knowledge Engineering

Plug into The Power of Knowledge Engineering.
Visit us at www.skf.com/knowledge

SKF

In Table 2- 2 a survey of the different types of hybridization and hybrid orbitals is given. The type of hybridization depends on the number of electron groups that surround the central atom. In order to sketch the type of hybridization of a molecule you have to follow the following list:

- 1) Write down the Lewis structure (section 2.2.3 *Lewis structure*)
- 2) Count the number of electron groups that surround the central atom
- 3) The number of required hybrid orbitals equals the number of surrounding electron groups.
Hybridization type is given in Table 2- 2.

These three steps are followed in Example 2- M, Example 2- N, and Example 2- O in this sub section. Until now we have been dealing with covalent bonds in single molecules. Now we are going to look at the bonds that exist in very large lattice structures between metal atoms. We are going into the world of metallic bonds.

2.3 Metallic bonds

In the previous sub sections we learned that the bond electrons in the covalent bonds are placed in hybrid molecular orbitals with totally specific directions. This means that the valence electrons thus are more or less “locked” in the bonds in those hybrid orbitals. Because of this “locking” of the electrons, covalent bonds generally are very poor at conducting electricity (since electricity consists of electrons being able to move freely). The very low electrical conductance of covalent bonds is the exact opposite of the case with metallic bonds. Metals have very high electrical conductance in all directions which thus implies that the metallic bonds are good at conducting electricity. Therefore metallic bonds and covalent bonds must be fundamentally different. We are going to look more into that in this section. We will also see how metal atoms are arranged in different *lattice structures*.

2.3.1 Band theory

A simple model to describe metallic bonds is the so-called *electron sea model*. Metals can be considered as metal cations surrounded by valence electrons that “swim” around in all directions like in a sea. That way metals have high electrical and thermal conductivity in all directions since the valence electrons freely can move around. In order to describe this in more details we have to introduce the so-called *band theory*. In the band theory the molecular orbitals (that we heard about in the section 2.2.2 *Molecular orbital theory*) are again used.

We will start with the metal lithium (Li) which is the first element of the 2nd period and thus has only one valence electron (placed in the 2s-orbital). If two lithium atoms approach each other the two atomic 2s-orbitals will be transformed into two molecular orbitals; a bond orbital (σ_{2s}) and an anti-bond orbital (σ_{2s}^*) according to the theory described in section 2.2.2 *Molecular orbital theory*. If we have four lithium atoms, the four atomic orbitals (2s) will be transformed into four molecular orbitals; two bond orbitals (σ_{2s}) and two anti-bond orbitals (σ_{2s}^*). From quantum mechanical considerations, the bond orbitals and anti-bond orbitals can not be degenerated. This means that they can not be equal in energy level and thus they will each have its own level of energy. If we have n lithium atoms (n is a very large number – for example the Avogadro number $n = 6.023 \times 10^{23} = 1 \text{ mol}$), the n atomic orbitals

(2s) will be transformed into n molecular orbitals; $\frac{1}{2}n$ bond orbitals (σ_{2s}) and $\frac{1}{2}n$ anti-bond orbitals (σ_{2s}^*). Since those n molecular orbitals can not be degenerated they must all be different in energy levels. Thus those energy levels must be very close and in practice they constitute a continuous energy *band*. The described situations are show in Figure 2- 19.

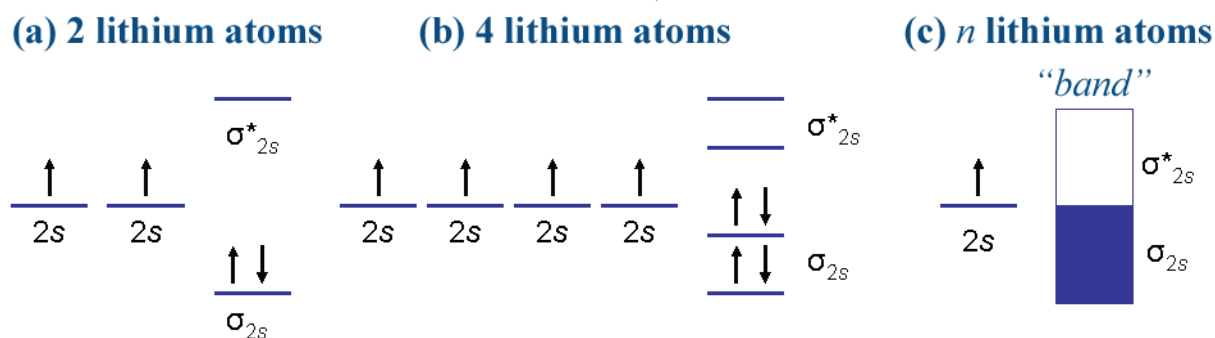

Figure 2- 19: The energy levels for the molecular orbitals for lithium metal

(a) Two lithium atoms together create two molecular orbitals. (b) Four lithium atoms together create four molecular orbitals. (c) n lithium atoms together create n molecular orbitals. When the number of atoms is large, the energy levels of the molecular orbitals created a continuous energy *band*.

Trust and responsibility

NNE and Pharmaplan have joined forces to create NNE Pharmaplan, the world's leading engineering and consultancy company focused entirely on the pharma and biotech industries.

Inés Aréizaga Esteva (Spain), 25 years old
Education: Chemical Engineer

– You have to be proactive and open-minded as a newcomer and make it clear to your colleagues what you are able to cope. The pharmaceutical field is new to me. But busy as they are, most of my colleagues find the time to teach me, and they also trust me. Even though it was a bit hard at first, I can feel over time that I am beginning to be taken seriously and that my contribution is appreciated.

Please click the advert



NNE Pharmaplan is the world's leading engineering and consultancy company focused entirely on the pharma and biotech industries. We employ more than 1500 people worldwide and offer global reach and local knowledge along with our all-encompassing list of services.
nnepharmaplan.com

nne pharmaplan®

The large amount of atomic orbitals constitutes in practice a continuous energy transition between the molecular orbitals. This is the energy *band*. The bond orbitals in lithium metal will be occupied each with one electron and the anti-bond orbitals are empty. Because the transition from bond orbital to anti-bond orbital is very small in terms of energy, the electrons can easily move from a bond orbital to an anti-bond orbital. Thus is easy to get a current of electrons transported through the metallic structure because the electrons can easily move in the empty anti-bond orbitals. They can flow through the metal as an *electron sea*. This is thus an explanation of the high metallic electrical conductance in all directions from the very simple *electron sea model* and the *band theory*. The high thermal conductivity follows in the aftermath of the high electrical conductance since the moving valence electrons transport heat as well.

2.3.2 Lattice structures

In the previous section we have seen how metal bond can be described according to the band theory. The valence electrons can freely move through the metal lattice in empty anti-bond orbitals since the energy transition between these orbitals is very low. But how are the single atoms arranged relative to each other? We are going to look at the answer to this question in this section. Generally two types of structures in solid compounds can be distinguished:

- Crystalline solid compounds
- Amorphous solid compounds

In crystalline solid compounds there is a high order of systematism in the structure which is in contrast to amorphous solid compounds which are characterized by totally lack of order in the structure. Metals belong to the first category. Metal atoms are arranged in so-called *crystal lattices*. Glas and ceramics are, on the other hand, amorphous compounds and we will not deal with these in this book. The atoms in crystal lattices can be arranged in different manners which mean that different metals can have different types of crystal lattices. We are going to look at how these different crystal lattices are organized. Initially we assume that the metal atoms can be regarded as hard spheres that can be stacked so that they just touch each other. Crystal lattices are in principle build up of very small identical units. The smallest existing unit is called a *unit cell*. These small building blocks/unit cells can be compared to Lego® building blocks. They are the smallest building units and they can be built up to constitute at very large structure. We are going to see several of these unit cells in the description of the different crystal lattice structures in this section. We are mainly going to look at the four major types of structures:

- Simple cubic packing (sc)
- Body-centered cubic packing (bcc)
- Hexagonal closest packing (hcp)
- Face-centered cubic packing (fcc)

The simplest lattice structure is the so-called *simple cubic packing* (sc). This structure consists of identical layers of atoms placed exactly above and below each other. The structure is sketched in Figure 2- 20.

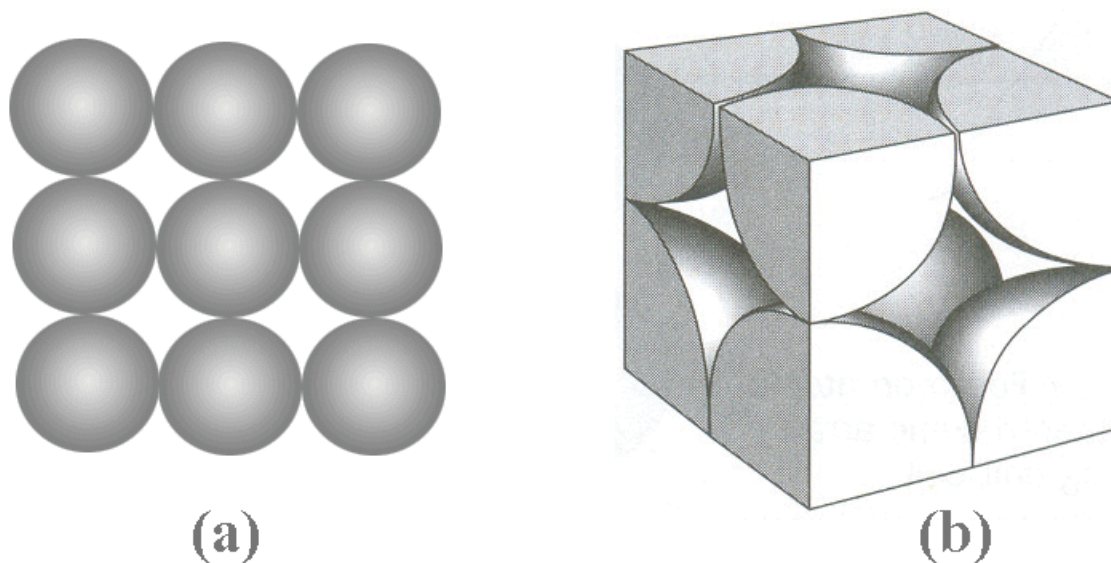

Figure 2- 20: Simple cubic packing (sc)

(a) One layer of the structure. (b) Unit cell. In the simple cubic packing every layer is placed exactly above and below each other. Thereby every atom touches six other atoms (four in the same layer, one above, and one below). Thus the coordination number is 6.

Only the metal polonium (Po) has its atoms arranged in a simple cubic packing structure. In Figure 2-20b it is seen that the unit cell in the sc-structure consists of 1 atom in total ($8 \times 1/8$ part of an atom). From the unit cell it is further seen that the atoms touch along the edges of the unit cell. Thus the lengths of the edges of the unit cell equals 2 times the atomic radius ($b = 2 \times r$). The length of the edges of the unit cell is denoted b and the atomic radius is denoted r . Each atom in the sc-structure thus touches 6 other atoms and therefore the so-called *coordination number* is 6.

The atoms in a metal can also be packed according to the so-called *body-centered cubic* packing structure (bcc). In this structure identical layers of atoms are placed above and below each other so that every second layer is exactly above and below each other. The atoms in one layer are placed above the holes in the layer below and above. This is sketched in Figure 2- 21a.

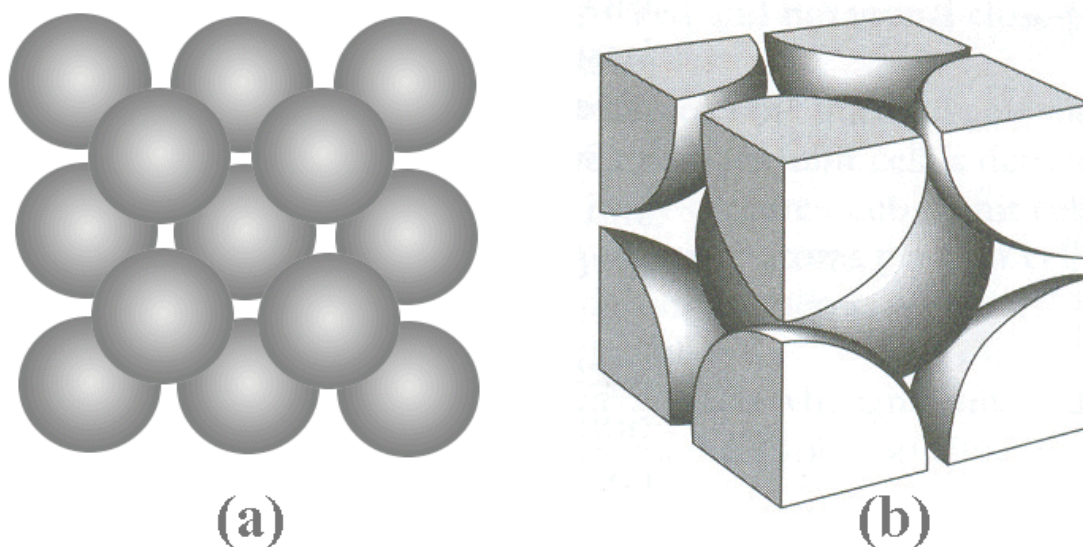

Figure 2- 21: Body-centered cubic packing (bcc)

(a) Two layers of the structure. (b) Unit cell. Every second layer is placed exactly above and below each other. Every atom touches eight other atoms (four in the layer below and four in the layer above). Thus the coordination number is 8.

Please click the advert

CHALLENGE YOURSELF

WWW.STUDYINSWEDEN.SE

Si.
Swedish Institute

Today's job market values ambitious, innovative, perceptive team players. Swedish universities foster these qualities through a forward-thinking culture where you're close to the latest ideas and global trends.

Whatever your career goals may be, studying in Sweden will give you valuable skills and a competitive advantage for your future. www.studyinsweden.se

In Figure 2- 21 it is seen that the atoms do not touch each other in the respective layers but they rather touch the atoms in the layer below and above. From the sketch of the unit cell it is seen that the atoms touch along the diagonal through the unit cell which gives rise to the name *body-centered* structure. Thus the length of the body-diagonal of the unit cell equals 4 times the atomic radius. By using the theorem of Pythagoras the length of the edge of the unit cell b is thus equal to: $b = (4/(3^{1/2})) \times r$. The unit cell contains 1 whole atom plus 8 times 1/8 parts of atoms which correspond to 2 atoms in total in the unit cell. Each atom touches eight other atoms which give rise to a coordination number of 8 for this structure.

In stead of a square based arrangement of the atoms in each layer (as in the *sc* and *bcc* structures), the atoms can be arranged in a hexagonal manner. This means that each atom does not have four neighbours but rather six neighbours in a layer. That way the holes between the atoms in the layer will by far be smaller compared to the *sc* and *bcc* structures and overall the atoms will packed closer together. There are two different types of hexagonal structures. The first is the *hexagonal closest packed* structure (*hcp*) and the second is the *face-centred cubic* structure (*fcc*). The hexagonal closest packed structure (*hcp*) is sketched in Figure 2- 22. In this structure every second layer is placed exactly above and below each other.

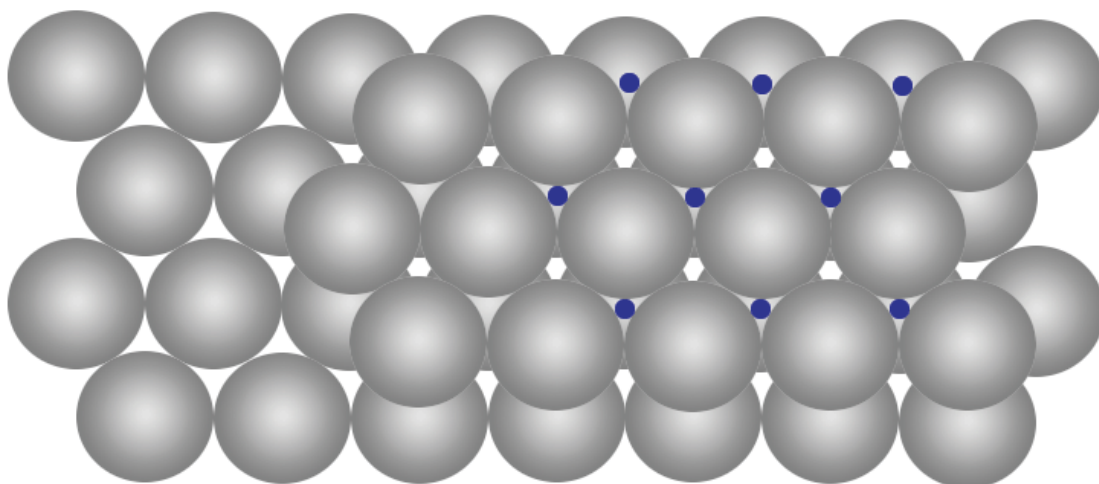

Figure 2- 22: Hexagonal closest packing (hcp)

Every second layer is placed exactly above and below each other. The centres of the atoms in the third layer are sketched with small blue dots. The third layer is placed exactly above the first layer. Every atom touches twelve other atoms (six in the same layer, three in the layer below, and three in the layer above). Thus the coordination number is 12.

Since each atom in the hcp-structure touches twelve other atoms (six in the same layer, three in the layer below, and three in the layer above) the coordination number is 12. A unit cell for this structure can not be drawn as easily as for the other structures and thus only the layered structure is shown in Figure 2- 22. It is seen that it is only 50% of the “holes” in the layers that are covered by atoms in the layer above/below.

The other hexagonal packed structure is the so-called *face-centred cubic* structure (*fcc*). Every third layer is placed above the holes in the first layer which means that every fourth layer is placed exactly above each other. The layered structure and the unit cell for the *fcc*-structure are sketched in Figure 2- 23.

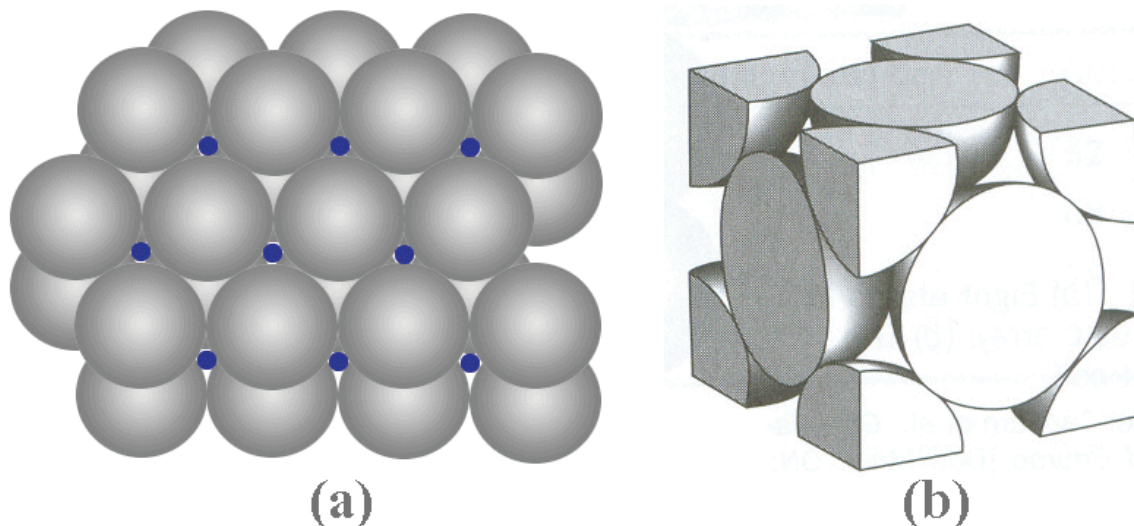

Figure 2- 23: Face-centered cubic packing (fcc)

(a) The centre of the atoms in the third layer is placed above the holes in the first layer and the centres of the atoms in the third layer are sketched with small blue dots. (b) Unit cell. Every atom touches twelve other atoms (six in the same layer, three in the layer above, and three in the layer below). Thus the coordination number is 12.

Please click the advert

The Milkround

LAUNCHING GRADUATE CAREERS

MILKROUND SYSTEM
Become a business star with internships, placements, graduate jobs & schemes from leading companies.
www.milkround.com

PLANET CAREER ADVICE
Inhabited by insights into business careers and orbited by application advice.

FIRST CONTACT
Get matched to top business employers via intelligent emails landing in your inbox.



Milkround.com: rated the #1 graduate recruitment website in the UK Graduate Careers Survey 2009 of 16,000 university finalists.

By comparing Figure 2- 22 and Figure 2- 23a it is seen that the difference between the *hcp*-structure and the *fcc*-structure lies in the placement of the third layer. As for the *hcp*-structure, each atom in the *fcc*-structure touches twelve other atoms (six in the same layer, three in the layer below, and three in the layer above). Thus the coordination number is 12. From the unit cell it is seen that the atoms touch each other along the diagonal of the “faces” of the unit cell. Thus the name for this structure is *face-centred* cubic structure, and the face-diagonal equals four times the atomic radius. By using the theorem of Pythagoras the length of the unit cell b can be calculated according to: $b = (8^{1/2}) \times r$. The unit cell contains six half atoms plus eight 1/8 parts of atoms which gives a total of 4 atoms pr. unit cell.

A survey of the four different structures is given in Table 2- 3.

Table 2- 3: Crystal lattice structures

The side length in the unit cell is denoted b and the radius of the atoms is denoted r . SC: simple cubic packing, BCC: Body-centered cubic packing, FCC: Face-centered cubic packing, HCP: Hexagonal closest packing.

Structure	Sketch	$b = f(r)$	Number of atoms in unit cell	Example
sc		$b = 2 \times r$	1	Polonium
bcc		$b = (4/3^{1/2}) \times r$	2	Niobium
fcc		$b = (8^{1/2}) \times r$	4	Osmium
hcp	*	-	-	Palladium

*The unit cell for the *hcp*-structure is not given since it can not be sketched with the same methodology as for the other structures.

We are now able to determine the side length of a unit cell for different lattice structures according to Table 2- 3. We also know the number of atoms in each unit cell and thus we can calculate the density of a metal when the atomic radius is known. We are going to try this in the following example.

Example 2- P: Density of tungsten (W)

The transition metal tungsten (W) attains *bcc*-structure. The atomic radius of tungsten atoms is 1.37 Å ($r = 1.37 \times 10^{-8} \text{ cm}$) and the molar mass of tungsten is $M_w = 183.84 \text{ g/mol}$. What is the density of tungsten metal?

We know that when we are dealing with *bcc*-structures each unit cell contains 2 atoms (see Table 2-3). The density of tungsten metal can thus be determined as follows:

$$\text{Density of tungsten} = \frac{\text{Mass of 2 W - atoms}}{\text{Volume of unit cell}}$$

The mass of 2 tungsten atoms can be calculated from the molar mass and Avogadro's number.

$$\text{Mass of 2 W - atom} = \frac{M_w}{N_A} \cdot 2 = \frac{183.84 \frac{\text{g}}{\text{mol}}}{6.022 \times 10^{23} \text{ mol}^{-1}} \cdot 2 = \underline{6.106 \times 10^{-22} \text{ g}}$$

The volume of the unit cell is determined from the atomic radius since we know the connection between the side length of the unit cell b and the atomic radius r according to Table 2-3.

$$\text{Volume of unit cell} = b^3 = \left[\left(\frac{4}{3^{1/2}} \right) \cdot r \right]^3 = \left[\left(\frac{4}{3^{1/2}} \right) \cdot 1.37 \times 10^{-8} \text{ cm} \right]^3 = \underline{3.167 \times 10^{-23} \text{ cm}^3}$$

The density of tungsten metal can now be calculated.

$$\text{Density of tungsten} = \frac{6.106 \times 10^{-22} \text{ g}}{3.167 \times 10^{-23} \text{ cm}^3} = \underline{\underline{19.28 \text{ g/cm}^3}}$$

The calculations can also go the other way. If the density of a metal and packing structure is known, the atomic radius can be calculated. We are going to try this in the following example.

Example 2- Q: Atomic radius for ruthenium (Ru)

The transition metal ruthenium (Ru) has *fcc*-structure. The density of ruthenium metal is 12.34 g/cm^3 and the molar mass is $M_{\text{Ru}} = 101.07 \text{ g/mol}$. What is the atomic radius of ruthenium atoms?

We know that when we are dealing with *fcc*-structure each unit cell contains 4 atoms according to Table 2- 3. The volume of the unit cell can thus be determined as follows:

$$\text{Volume of unit cell} = \frac{\text{Mass of 4 Ru - atoms}}{\text{Density of Ruthenium}}$$

The mass of 4 ruthenium atoms is calculated from the molar mass and the Avogadro's number.

$$\text{Mass of 4 Ru - atoms} = \frac{M_{\text{Ru}}}{N_A} \cdot 4 = \frac{101.07 \frac{\text{g}}{\text{mol}}}{6.022 \times 10^{23} \text{ mol}^{-1}} \cdot 4 = \underline{6.713 \times 10^{-22} \text{ g}}$$

The volume of the unit cell is calculated.

Please click the advert



oxygen.ie

Download 3rd level revision guides for free
– brought to you by oxygen.ie

$$\text{Volume of unit cell} = \frac{6.713 \times 10^{-22} \text{ g}}{12.37 \text{ g/cm}^3} = 5.427 \times 10^{-23} \text{ cm}^3$$

The volume of the unit cell equals the side length of unit cell raised to the power of three (Volume = b^3). Since we know the association between the side length b of the unit cell and the atomic radius r according to Table 2-3, the atomic radius of ruthenium can now be calculated.

$$\begin{aligned} \text{Volume of unit cell} = b^3 &= [(8^{1/2}) \cdot r]^3 \Leftrightarrow \\ r &= \frac{(\text{Volume of unit cell})^{1/3}}{8^{1/2}} = \frac{(5.427 \times 10^{-23} \text{ cm}^3)^{1/3}}{8^{1/2}} = 1.34 \times 10^{-8} \text{ cm} = \underline{1.34 \text{ \AA}} \end{aligned}$$

Now we have been looking at metallic bonds and how metal atoms arrange in crystal lattice structures. In the following section we are going to look at the ionic bonds and compounds.

2.4 Ionic bonds

The transition from pure covalent bonds over polar covalent bonds to ionic bonds is a continuous gradient of polarity as described in the section *2.1.1 Bond types*. In this section we are going to look at bonds with ionic character. We are also going to look at how ionic compounds often are arranged in crystal lattices similar to the metallic structures described in the section *2.3.2 Lattice structures*.

2.4.1 Ionic character

When the electronegativity between two atoms is zero (two identical atoms) you have a pure covalent bond while the bond is polar covalent if there is a difference in electronegativity between the atoms. When this difference in electronegativity reaches a certain level, at which the bond electrons in practice are totally placed around the most electronegative atom, the bond is categorized as ionic since we no longer have a bond electron pair but rather some electrostatic interactions between a cation and an anion. For chemical bonds one can talk about how much ionic character the bond exhibits. The ionic character can be calculated based on electron charge and bond distance which we will not go further into in this book. A relative connection between the degree of ionic character and difference in electronegativity between the atoms is sketched in Figure 2-24.

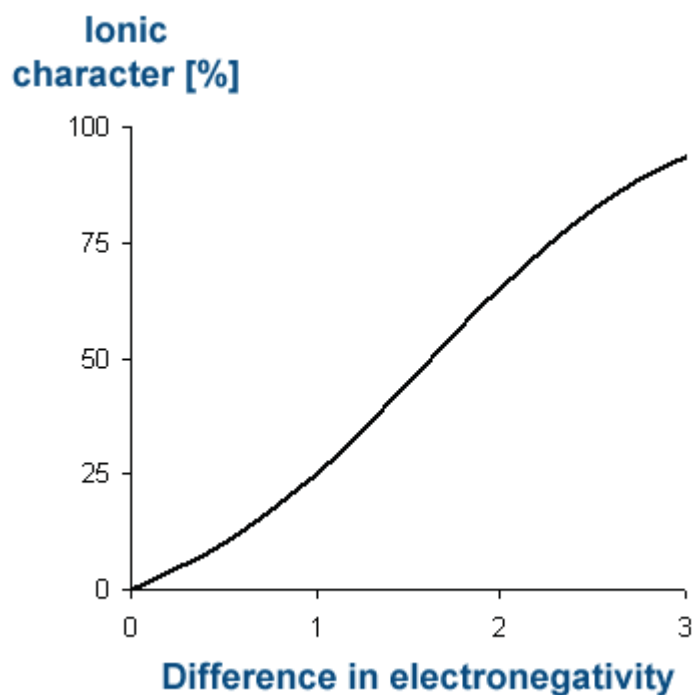

Figure 2- 24: Ionic character

Connection between the ionic character of a bond and the difference in electronegativity between the two atoms in a chemical bond.

A pure covalent bond (an H-H bond for example) exhibits 0 % ionic character while a polar covalent bond like hydrogen fluoride (H-F) exhibits 42 % ionic character. Bonds in sodium chloride (NaCl) are normally considered as ionic. These sodium chloride bonds exhibit 72 % ionic character. This emphasizes that the transition between covalent bonds over polar covalent bonds to ionic bonds is a continuous gradient of polarity. No bonds actually exhibit 100 % ionic character since the bond electrons always will be located around the less electronegative atom at least for just a very little percentage of the time.

The strength of an ionic bond depends on the size of the ions. The smaller an ion the smaller is the surface area. This means that the charge of the ion “only” has to be distributed throughout a smaller area and the *charge density* thus increases when the ionic radius decreases. When the charge density is larger, the ionic bonds increase in strength. Therefore a LiF bond is stronger than a LiI bond since the radius of fluoride is smaller than the radius of iodide and thus the charge density of fluoride is larger than for iodide. This means that fluoride will be stronger bonded to the lithium ion than iodide.

2.4.2 Lattice structures for ionic compounds

We saw in the section 2.3.2 *Lattice structures* that metal atoms are arranged in different crystal lattice structures. The same is the case for many solid ionic compounds. The anions are often much larger than the cations so these anions often constitute the lattice structure and the cations are then located in the holes in the lattice structure. As for the metal atoms we assume that the ions are hard spheres that can be packed together so that they just touch each other. The ratio between the radius of the cations and the anion determines which lattice structure the ionic compound adopts. This ratio is called the r_+/r_- ratio. In Table 2- 4 you can see which structure the ionic compounds adopt at the different r_+/r_- ratios. Of course there are some exceptions which you can find information about in more detailed educational textbooks. The coordination number tells how many anions each cation touches in the lattice structure.

Table 2- 4: Structures for ionic compounds

The structure of an ionic compound depends on the r_+/r_- ratio. The coordination number tells how many anions each cation touches.

r_+ / r_- ratio	Coordination number	Name of structure	Example
0.732 – 0.999	8	Cubic	CsCl
0.414 – 0.732	6	Octahedral	NaCl
0.225 – 0.414	4	Tetrahedral	ZnS

Please click the advert



DIVERSE - INNOVATIVE - INTERNATIONAL

Are you considering a European business degree?

Copenhagen Business School is one of the largest business schools in Northern Europe with more than 15,000 students from Europe, North America, Australia and Asia.

Are you curious to know how a modern European business school competes with a diverse, innovative and international study environment?

Please visit Copenhagen Business School at www.cbs.dk



Copenhagen Business School
HANDELSHØJSKOLEN

Diversity creating knowledge



When the r_+/r_- ratio is between 0.732 and 0.999 the structure is cubic. In this case the cations and anions are not that different in size and the structure corresponds to the simple cubic structure (sc) that we heard about for metals (section 2.3.2 *Lattice structures*). Anions and cations will be placed in a simple cubic structure so that each cation will be surrounded by eight anions and vice versa. A unit cell for such a structure is shown in Figure 2- 25.

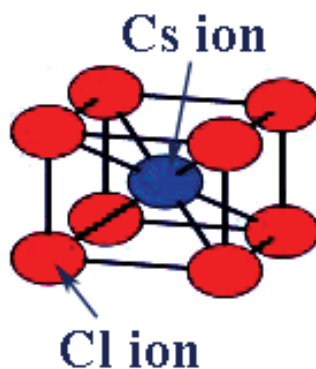

Figure 2- 25: Cubic structure for an ionic compound

Unit cell for a cubic structure for an ionic compound with a r_+/r_- ratio in the interval 0.732 – 0.999. Each cation touches eight anions and each anion touches eight cations. Cesium chloride (CsCl) is an example of an ionic compound with cubic structure.

In Figure 2- 25 it is sketched that in the unit cell the ions touch along the diagonal through the unit cell. This means that the diagonal has a length that corresponds to $2 \times \text{radius of anion} + 2 \times \text{radius of cation}$. Such a structure is seen for cesium chloride.

When the r_+/r_- ratio is between 0.414 and 0.732 the structure is octahedral. This means that the cations are placed in the octahedral holes in the anionic lattice. This structure is called *sodium chloride structure* because the well known common salt used for cooking has this structure. The sodium chloride structure for a unit cell is sketched in Figure 2- 26.

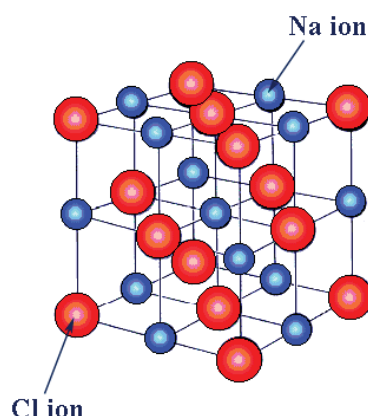

Figure 2- 26: Octahedral structure for an ionic compound

Octahedral structure for an ionic compound with a r_+/r_- ratio in the interval 0.414 – 0.732. The cations are placed in the octahedral holes in the anion lattice. Thus each cation touches six anions. This structure is often called sodium chloride structure since "common salt" has this structure.

In Figure 2- 26 it is seen that the cations are placed in the octahedral holes in the anionic lattice. Thus the cations each have six anion neighbours. From geometrical considerations the radius of the octahedral holes be calculated from the radius of the anions according to equation (2- 4).

$$r_{\text{octahedral holes}} = 0.414 \cdot r_{\text{anion}} \quad (2- 4)$$

When the r_+/r_- ration is between 0.225 and 0.414 the structure is tetrahedral. In this case the cations are relatively small compared to the anions. Thus they fit into the tetrahedral holes of the anion structure. This is sketched for a zinc sulphide lattice in Figure 2- 27.

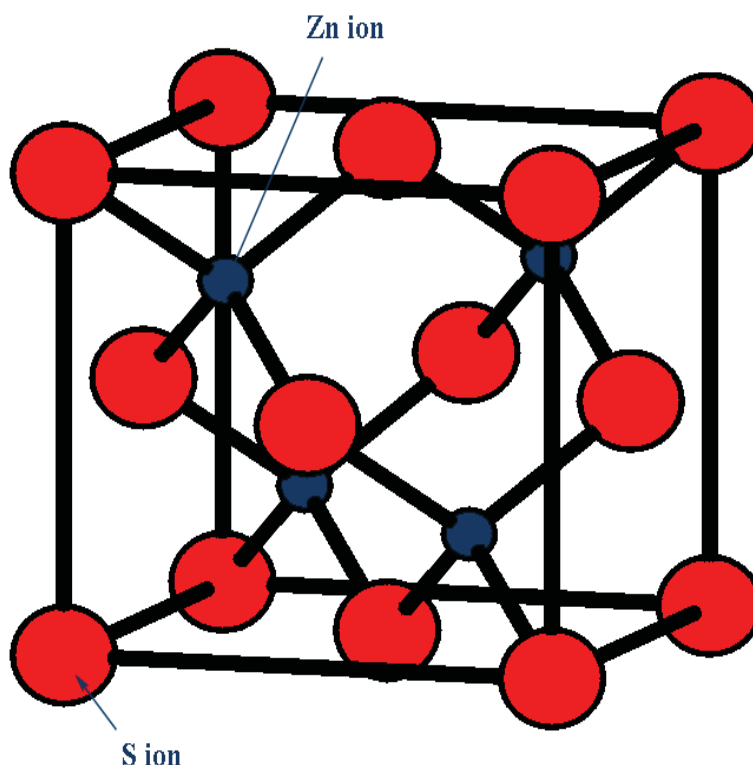

Figure 2- 27: Tetrahedral structure for an ionic compound

Ionic compound with a r_+/r_- ration in the interval 0.225 – 0.414. The cations are placed in the tetrahedral holes of the anion structure. Thus each cation touches four anions. Zinc sulphide (ZnS) is an example of an ionic compound with tetrahedral structure.

The anions are arranged in a cubic close packed system and the cations are located in the tetrahedral holes of this structure. Thus each cation has four anion neighbours. From geometrical considerations the radius of the tetrahedral holes can be calculated from the radius of the anions according to equation (2- 5).

$$r_{\text{tetrahedral holes}} = 0.225 \cdot r_{\text{anion}} \quad (2- 5)$$

By looking at the equations (2- 4) and (2- 5) you can see why it is at the r_+/r_- ratios of 0.225 and 0.414 (according to Table 2- 4) that we have the lower limits for the tetrahedral and octahedral structures, respectively.

2.4.3 Energy calculations for ionic compounds

In the previous section we saw how ionic compounds often are arranged in different lattice structures depending on the ratio between the cation radius and the anion radius. In this section we are going to look at the *lattice energy* in an ionic compound and how one can calculate the total change in energy when for example lithium metal and fluorine gas reacts into the formation of solid lithium fluoride. Using lithium fluoride as an example, we shall now see how we can play with different energy terms such as lattice energy, ionization energy, sublimation energy, and so forth.

Please click the advert



Sharp Minds - Bright Ideas!

Employees at FOSS Analytical A/S are living proof of the company value - First - using new inventions to make dedicated solutions for our customers. With sharp minds and cross functional teamwork, we constantly strive to develop new unique products - Would you like to join our team?

FOSS works diligently with innovation and development as basis for its growth. It is reflected in the fact that more than 200 of the 1200 employees in FOSS work with Research & Development in Scandinavia and USA. Engineers at FOSS work in production, development and marketing, within a wide range of different fields, i.e. Chemistry, Electronics, Mechanics, Software, Optics, Microbiology, Chemometrics.

We offer
A challenging job in an international and innovative company that is leading in its field. You will get the opportunity to work with the most advanced technology together with highly skilled colleagues.

Read more about FOSS at www.foss.dk - or go directly to our student site www.foss.dk/sharpminds where you can learn more about your possibilities of working together with us on projects, your thesis etc.

The Family owned FOSS group is the world leader as supplier of dedicated, high-tech analytical solutions which measure and control the quality and production of agricultural, food, pharmaceutical and chemical products. Main activities are initiated from Denmark, Sweden and USA with headquarters domiciled in Hillerød, DK. The products are marketed globally by 23 sales companies and an extensive net of distributors. In line with the corevalue to be 'First', the company intends to expand its market position.



Dedicated Analytical Solutions

FOSS
 Slangerupgade 69
 3400 Hillerød
 Tel. +45 70103370
www.foss.dk

Example 2- R: Energy calculations for lithium fluoride (LiF)

What is the total change in energy when lithium metal reacts with fluorine gas and forms solid lithium fluoride?

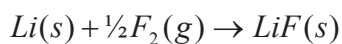

The energy changes are sketched in Figure 2- 28. We are looking at the case of 1 mol of lithium atoms that reacts with a $\frac{1}{2}$ mol of fluorine gas molecules and 1 mol of solid lithium fluoride is formed.

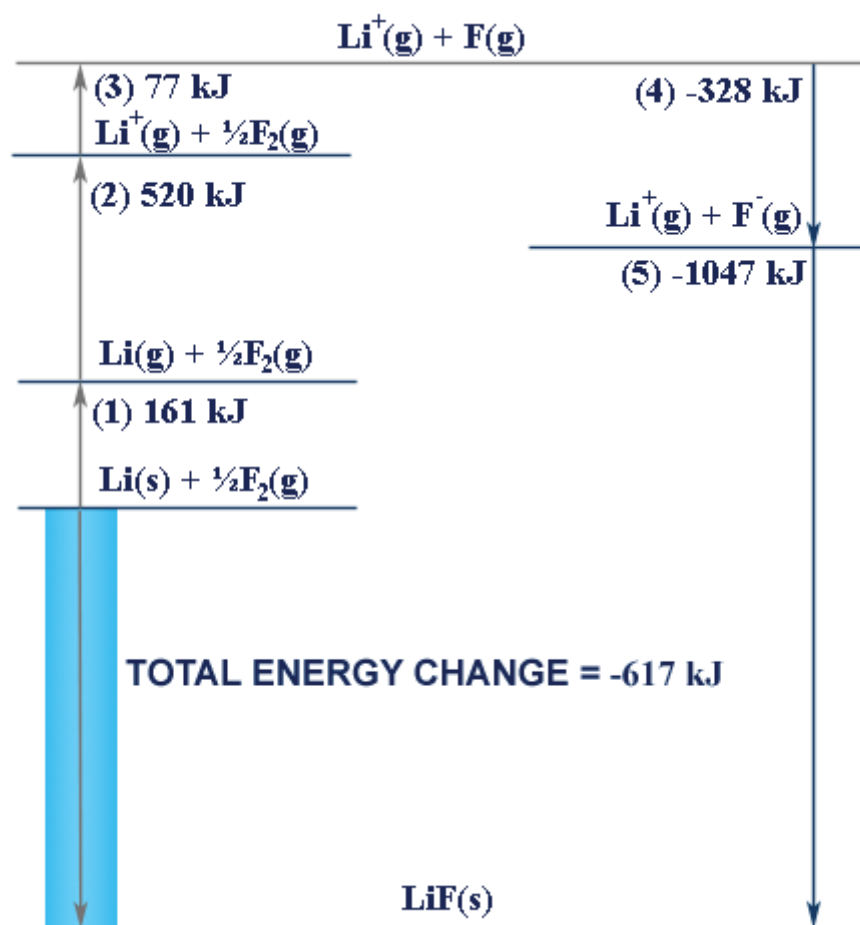

Figure 2- 28: Energy diagram for the formation of lithium fluoride

The arrows pointing upwards indicate that energy has to be supplied in order to make the reaction occur. The arrows pointing downwards indicate that energy is released when the reaction occurs. 1 mol of solid lithium fluoride is formed.

The single steps are explained below:

- 1) The first step is to sublimate the lithium metal into lithium gas. The sublimation enthalpy is 161 kJ/mol (enthalpy is a thermodynamic property related to e.g. a phase change). Thus 161 kJ are required.
- 2) The second step is to get the lithium gas atom ionized. The ionization energy for lithium is 520 kJ/mol. Thus 520 kJ are required.
- 3) The third step is to break the covalent F-F bonds in order to get single fluorine atoms. It requires 154 kJ/mol to break the bonds and since a half mol of bonds is to be broken, 77 kJ are required.
- 4) The fourth step is to let the fluorine atom each adopt an electron. The energy change here is thus the electron affinity for fluorine which is -328 kJ/mol. Thus 328 kJ are released.
- 5) The fifth step is to let the lithium ions and the fluoride react and form solid lithium fluoride. The energy change corresponds to the lattice energy for LiF which is 1047 kJ/mol. Thus when 1 mol of LiF is formed from the gaseous ions, 1047 kJ will be released.

The total change in energy can be determined by summing up the energies in the five steps.

$$\text{Total energy change} = (161 + 520 + 77 + (-328) + (-1047)) \text{ kJ} = \underline{\underline{-617 \text{ kJ}}}$$

Thus 617 kJ are released when 1 mol of LiF(s) is formed from 1 mol of Li(s) and $\frac{1}{2}$ mol of F₂(g)

By setting up an energy diagram as in Figure 2- 28 you are able to calculate different energy terms when the other terms are known. Many of the terms can be looked up in tables in the literature and educational textbooks.

Please click the advert

**Design your
own future at
MAN Diesel**

www.mandiesel.com

MAN Diesel – Powering the World



Download free books at BookBooN.com

2.5 Summing up on chapter 2

In this chapter we have been looking at three types of chemical bonds; covalent bond, ionic bonds, and metallic bonds. The bonds are described by using different models and theory which introduce the molecular orbitals. These molecular orbitals are formed from atomic orbitals which we heard about in chapter 1.

In the section 2.2 *Covalent bonds* we introduced some considerations about energy changes associated with formation of chemical bonds. We concluded that in order for a chemical bond to be formed the total energy between the two atoms must have a minimum at a certain distance between the atoms. This distance is the length of the covalent bond. Molecular orbital theory is used in the explanation of why some atoms join and form molecules while others do not. We introduced the bond orbitals and the anti-bond orbitals. By use of molecular orbital theory we were able to predict bond orders. Thus we can predict whether a bond is a single, double, or triple bond. In order to talk about the arrangement of different atoms inside a molecule or composite ion we learned how to determine Lewis structures. Lewis structures could also tell about the bond order and the arrangement of electron groups (lone pairs or bond electron pairs) around the central atom in a molecule or composite ion. Such information is useful when the VSEPR theory is to be applied. The VSEPR theory tells us that the electron groups around an atom will be placed as far apart as possible. Thus the VSEPR theory is a tool that helps us to predict the actual geometry of a molecule or composite ion. However, the VSEPR theory tells nothing about where the different electron groups precisely are located or to put it another way; in which orbitals are the electron groups hosted? In order to answer this question we introduced the orbital hybridization theory. From this theory we know that atomic orbitals transform or “melt” into molecular hybrid orbitals with the “right” orientation in space according the VSEPR theory. The type of hybridization depends on how many electron groups that surround the central atom.

The bond electrons in covalent bond are “locked” in the hybrid orbitals which gives poor electrical conductance. This is in contrast to the bonds in metals. These bonds can be described by an *electron sea model* that tells us that valence electrons freely can move around in the metallic structure. The band theory tells us that the valence electrons move around in empty anti-bond orbitals that all lie very close in energy to the bond orbitals. The free movement of electrons in metals explain the very high electrical and thermal conductivity of metals. Metal atoms are arranged in different lattice structures. We saw how knowledge about the lattice structure and atomic radius can lead to calculation of the density of a metal.

Ionic bonds are described as well. The transition from covalent over polar covalent to ionic bonds is a continuous gradient of polarity and depends on the difference in electronegativity between the atoms. In covalent bonds an electron pair is shared whereas ionic bonds are more to be considered as electrostatic interactions between a cation and an anion. Solid ionic compounds are often arranged in lattice structures with many similarities to the lattice structures that we saw for the metallic compounds. The type of lattice structure for solid ionic compound depends on the ratio between the radius of the cation and anion.

3. Reaction kinetics

Understanding chemical reaction kinetics is essential for a chemist. In this chapter, you will be introduced to the fundamental aspects of chemical reactions, stoichiometric considerations, and rates of chemical reactions.

3.1 Chemical reactions

A chemical reaction is defined by reactants reacting to form products. When all products and reactants are known, e.g. from an experiment, it is possible to set up a chemical stoichiometric balance. From stoichiometric considerations, the number of atoms/ions on the product side must equal the number of atoms/ions on reactant side. When talking about a “side” of a chemical reaction, we are referring to a side on a reaction arrow, being an arrow defining a chemical reaction by a reactant side and a product side.

Example 3- A: Writing down a chemical reaction

Adding barium chloride (BaCl_2) to an aqueous solution of sodium sulphate (Na_2SO_4), barium sulphate (BaSO_4) will be formed as a precipitate. When writing down this reaction, BaCl_2 and Na_2SO_4 are written on the reactant side on a reaction arrow. The product, BaSO_4 , is written on the product side, being the right side:



However, from stoichiometric considerations, something is missing! The chloride and sodium ions from the reactant side can not just disappear. The number of specific ions must be equal on each side of the reaction arrow. Thus, two chloride and two sodium ions must be added on the product side of the reaction arrow in order to fulfil the stoichiometric balance.



In an aqueous solution, a sodium ion and chloride will normally be dissociated; exist as ions. However, when writing down a chemical reaction, one is free to write chloride and sodium ions as sodium chloride, NaCl :

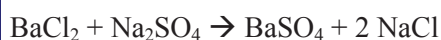

In this written representation of a chemical reaction, the stoichiometry is balance.

For a chemical reaction, one can talk about the spontaneity of the reaction to occur, being the “willingness” of the chemical reaction to occur by itself. Willingness, in this case, refers to energy considerations. If, from an energy minimization point of view, it is beneficial for a chemical reaction to occur by itself, it does not mean that the reaction will occur fast. It can take one nano second or it can take one billion years! It is all a matter of *reaction rate*. This part of the “universe of chemistry” is known as *chemical reaction kinetics*.

Example 3- B: Production of ammonia

The production of ammonia, NH_3 , is one of the most important chemical reactions. One use of ammonia is as a fertiliser which is very important for agriculture production. To put it roughly, around 20 million tonnes of ammonia is produced each year. The formation of ammonia can be expressed as:

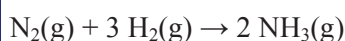

However, nitrogen and hydrogen gas under normal conditions (25°C and 1 atmosphere pressure) in practice do not react and form ammonia because the rate of reaction is extremely slow. Thus, one has to find other ways to producing NH_3 than just trying to let nitrogen and hydrogen react directly. This illustrates that even if the reaction actually may proceed, from a thermodynamic point of view, and even if the stoichiometry is balanced, it is not certain that the reaction actually will take place fast enough to produce the products. It is necessary to know something about the reaction rate.

3.2 Reaction rate

For a chemical reaction, the concentration of reactants and products changes with time. For an arbitrary specie, A , with the concentration $[A]$, the rate of reaction can be expressed as:

$$\text{Rate of reaction} = \frac{\Delta[A]}{\Delta[t]} \rightarrow \frac{d[A]}{dt} \quad (3- 1)$$

Example 3- C: Decomposition of nitrogen dioxide

We have a gas flask filled with NO₂ at room temperature (25 °C). At this temperature, NO₂ is stable, but if the gas is heated to 300 °C, it decompose to NO and O₂:



The concentrations of the three gases at different times are measured:

Time (s)	Concentration of NO ₂ (mol/l)	Concentration of NO (mol/l)	Concentration of O ₂ (mol/l)
0	0,01	0	0
50	0,0079	0,0021	0,0011
100	0,0065	0,0035	0,0018
150	0,0055	0,0045	0,0023
200	0,0048	0,0052	0,0026
250	0,0043	0,0057	0,0029
300	0,0038	0,0062	0,0031
350	0,0034	0,0066	0,0033
400	0,0031	0,0069	0,0035

By applying equation (3-1), it becomes possible to determine the velocity, by which O₂ is formed. For instance, O₂ is formed in the time interval 200 s → 250 s with a velocity of

$$\text{Rate of reaction (formation of O}_2) = \frac{\Delta[A]}{\Delta[t]} = \frac{(0,0029 \text{ mol/L} - 0,0026 \text{ mol/L})}{(250\text{s} - 200\text{s})} = 6.0 \times 10^{-6} \frac{\text{mol}}{\text{L} \cdot \text{s}}$$

while the velocity in the interval 350 s → 400 s is:

$$\text{Rate of reaction (formation of O}_2) = \frac{\Delta[A]}{\Delta[t]} = \frac{(0,0035 \text{ mol/L} - 0,0033 \text{ mol/L})}{(400\text{s} - 350\text{s})} = 4.0 \times 10^{-6} \frac{\text{mol}}{\text{L} \cdot \text{s}}$$

Thus, one sees that the rate of reaction is not constant. It actually decreases with time in this case. Following the stoichiometry for the conversion of NO₂, two molecules of NO₂ is converted each time a molecule of O₂ is formed. Thus, the conversion of NO₂ must take place with a velocity twice as high as the formation velocity of O₂. Hence, we may summarize the rate of reaction as follows:

$$\text{Velocity for the use of NO}_2 = \text{Velocity for the formation of NO} = 2 \times \text{Velocity for the formation of O}_2$$

3.3 Rate expressions

So far we have only looked at irreversible reactions. However, all reactions are in principle reversible, meaning that the reactions can occur in both directions (from reactant to product and from product to reactant). From the previous example, the decomposition of nitrogen dioxide, the reverse reaction may also occur:



This reaction can of course influence the reaction rate of the reaction in Example 3-C. The overall reaction rate can be expressed as:

$$\text{Rate of reaction} = k \cdot [\text{NO}_2]^n \quad (3-2)$$

Such an expression, describing how the rate of reaction depends upon the concentration of reactant, is called a *rate expression*. The proportionality constant, k , is referred to as a *rate constant* and n is the *order of reaction*. The order of reaction can only be determined based upon experimental data. The order of reaction may be positive as well as negative. In general, rate expressions are studied under conditions where n is 0, 1, or 2 since, in these cases, analytical solutions for rate expressions can be derived. When n is 0, the reaction is a *zero order reaction*, while we have a *first order* and *second order reaction* when n is 1 or 2, respectively.

Please click the advert

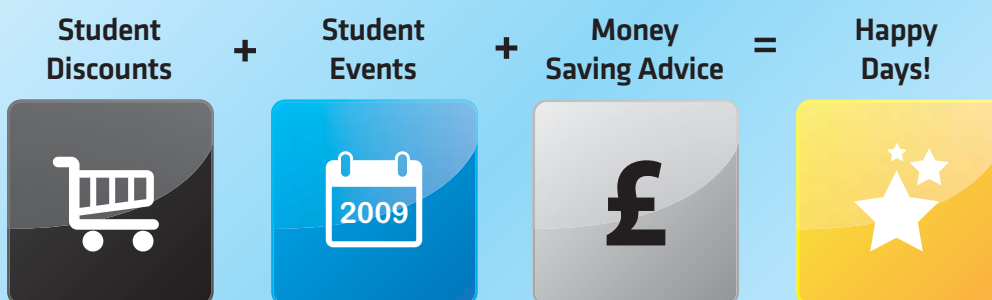

wealthystudent.co.uk

Example 3- D: Order of reaction and rate expressions

For a first order reactions, n equals 1, the general rate expression for the use of reactant A can be expressed as:

$$\text{Rate for the use of A} = -\frac{d[A]}{dt} = k \cdot [A]^n = k \cdot [A], \quad n = 1$$

This differential equation can be solve analytically and it can be shown that the concentration of reactant A depends upon the initial concentration of A, $[A]_0$, the rate constant, k , and time, t :

$$[A] = [A]_0 \cdot \exp(-k \cdot t)$$

For a second order reaction, n equals 2, the expression for the use of reactant A is:

$$\text{Rate of reaction for the use of A} = -\frac{d[A]}{dt} = k \cdot [A]^n = k \cdot [A]^2, \quad n = 2$$

Analogously, one derives the solution by solving the differential equation:

$$\frac{1}{[A]} = k \cdot t + \frac{1}{[A]_0}$$

When the order of reaction is zero, the following expression is obtained:

$$\text{Rate of reaction for the use of A} = -\frac{d[A]}{dt} = k \cdot [A]^n = k, \quad n = 0$$

For zero order reactions, the rate of reaction is constant and does not depend upon the concentration of reactant. By integration of the differential equation, one gets the following linear expression for the concentration of A as function of time, rate constant, k , as well as initial concentration of A, $[A]_0$:

$$[A] = -k \cdot t + [A]_0$$

3.4 Kinetics and catalysts

What affects the reaction rate besides the stoichiometry? Temperature is the answer. Temperature highly affects the level of the rate of reaction. The Arrhenius-equation, named after the Swedish chemist Svante Arrhenius, proposes a correlation between reaction rate and temperature:

$$\ln(k) = -\frac{E_a}{R} \frac{1}{T} + \ln(A) \quad (3-3)$$

The term R is the universal gas constant, T is the temperature in Kelvin (absolute temperature), and E_a is the energy of activation. One can imagine that if a reaction should take place, the reactants must somehow collide in order to become products. This requires a certain amount of energy equal to the energy of activation; E_a . If E_a is high, it is difficult to make the products (much energy is required) whereas it is easy to obtain the products if E_a is small. In the following example we shall look at a situation in which E_a is calculated using the Arrhenius-equation.

Example 3- E: Energy of activation

The following gas phase reaction has been studied under different conditions:



The rate constant k , at 30 °C, has been determined to $7.3 \times 10^{-5} \text{ s}^{-1}$ and for a temperature of 60 °C; $2.9 \times 10^{-3} \text{ s}^{-1}$. We want to calculate the energy of activation, E_a .

We set up the following expression on the basis of equation 3-3, for a temperature of 30 °C:

$$\ln(7.3 \times 10^{-5}) = -\frac{E_a}{R} \frac{1}{(273.15 + 30)} + \ln(A)$$

And for a temperature of 60 °C:

$$\ln(2.9 \times 10^{-3}) = -\frac{E_a}{R} \frac{1}{(273.15 + 60)} + \ln(A)$$

By subtracting the first expression from the last one, the following equation is obtained:

$$\ln\left(\frac{2.9 \times 10^{-3}}{7.3 \times 10^{-5}}\right) = \frac{E_a}{8.314} \left(\frac{1}{(273.15 + 30)} - \frac{1}{(273.15 + 60)} \right) \Leftrightarrow E_a = 1.0 \times 10^5 \text{ J/mol}$$

Thus, the activation energy of the reaction is 100 kJ pr. mol.

Since the rate of reaction, in general, is highly affected by temperature, one could jump to the conclusion that it is smart just to either turn up or turn down the temperature in order to control the reaction rate. It is often possible, but not always! In some cases, one cannot just increase the temperature in order to increase a reaction rate. As an example, many of the vital functions in the human body are highly sensitive to temperature changes and can only increase in rate to a limited temperature. Furthermore, it is often costly to increase the temperature in a chemical production plant in the energy of activation barrier has to be passed. What do you do then? Catalysts are the solution to many problems in which it is necessary to increase the rate of reaction without having to increase the temperature. A catalyst is a chemical compound that speeds up a chemical reaction. The catalyst helps converting large amount of reactant molecules into product molecules without being changed or used itself; this is a huge advantage of catalysts.

How do catalysts then work? As mentioned earlier, it is required that reactants overcome a certain energy barrier, the energy of activation, before they become products. A catalyst decreases the energy of activation, making the reaction proceed with less energy required. Catalysts are divided into two classes; homogenous and heterogeneous. A homogenous catalyst is present in same phase as the as the reactants. A heterogeneous catalyst, on the other hand, is present in another phase than the reactants; typically a solid catalyst helps liquid or gas phase reactants to form products on the surface of the catalyst.

Please click the advert



Read The Spanner online on oxygen.ie

Download free books at BookBooN.com

Example 3- F: Enzymes – catalysts of nature

Some of the most advanced homogenous catalysts are found in nature; enzymes. Enzymes help numerous reactions to occur which are vital for plants and life. Enzymes are large protein molecules, thus environmentally and biodegradable, highly specified and selective for speeding up certain chemical and biochemical reactions; typically hydrolysis or oxidation. Without enzymes, the hydrolysis of certain starch compounds at certain conditions might take many years whereas with enzymes, the rate of reaction could be well below 1 second! Nowadays, enzymes comprise a part of almost every aspect of our daily life; enzymes in detergents, enzymes in animal feed, enzymes in industrial baking, enzymes in the brewing industry, enzymes used for biofuel production, ect.

Enzymes are attractive to companies in the chemical and biochemical industry since enzymes are less harmful to the environment than other types of catalysts. Thus, the use of enzymes can help a company to lower their carbon dioxide emission from their production. Thus, the company can become more “green” and help changing our climate.

3.5 Kinetics of radioactive decay

Atoms with a different amount of neutrons but equal amount of protons in the nucleus are called isotopes which we realized earlier in this book. Furthermore, we saw that nucleons comprise both neutrons and protons and that radioactive isotopes decay under emission of different types of radiation. The rate of such decay is, in principle, similar to the rate of reaction which we have just been looking at. For a specific time, $t = 0$, we have N_0 radioactive isotopes. It has been found that all isotopes have a specific probability of decaying within the next second. If this probability is e.g. 1/100 pr. second, on average 1% of all these nuclei decay each second. The number of radioactive nuclei is thereby a decreasing function of time and is written as $N(t)$. The rate for the average number of decays pr. time is defined, analogously to equation (3-1), as:

$$\text{Rate of decay} = -\frac{\Delta N}{\Delta t} \rightarrow -\frac{dN}{dt} \quad (3-4)$$

The minus sign indicates that the number of radioactive nuclei is decreasing. The fraction in equation (3-4) is called the activity and is denoted $A(t)$. The unit for the activity is s^{-1} and is often also denoted as *Becquerel*. The probability that a certain nucleus decays within a certain time interval is denoted by the constant of decay, denoted k . Thereby equation (3-4) can be written as:

$$\text{Rate of decay} = -\frac{dN}{dt} = k \cdot N(t) = A(t) \quad (3-5)$$

By integrating equation (3- 5) it can be shown that $N(t)$ depends upon the constant of decay k , time t , and the “initial” number of radioactive nuclei N_0 :

$$N(t) = N_0 \cdot \exp(-k \cdot t) \quad (3- 6)$$

When talking about radioactivity, the so-called *half-life* is very important to consider. The half-life indicates how long it takes before the radioactivity of an isotope is decreased to half of the initial level. It is denoted $t_{1/2}$ and given by:

$$t_{1/2} = \frac{\ln 2}{k} \quad (3- 7)$$

The term k is the decay constant. The half-life of radioactive nuclei varies significantly from one type of isotope to another. Uranium-isotopes ^{238}U have a half-life of around 4.5 billion years whereas the bismuths isotope ^{214}Bi has a half-life of only around 20 minutes. When the half-life of an isotope is known, it is possible to determine the decay constant k and thereby calculate the activity and the number of radioactive nuclei to a given time.

Please click the advert

WHAT'S MISSING IN THIS EQUATION?

You could be one of our future talents

MAERSK INTERNATIONAL TECHNOLOGY & SCIENCE PROGRAMME

Are you about to graduate as an **engineer** or **geoscientist**? Or have you already graduated?
If so, there may be an exciting future for you with A.P. Moller - Maersk.



MAERSK

www.maersk.com/mitas

Example 3- G: Radon in the cellar!

Radon is a gas that comes from the solid radioactive element *radium* which is found all over in the earth in different amounts. Radon is radioactive and can be found in measurable amounts in our cellars. Radon penetrates into building, primarily through cracks in the building fundament.

In a concrete cellar, the activity of radon has been measured to 200 Becquerel from 1 m³ of air. If the cellar walls and floor were isolated such that no “new” radon could diffuse through the walls and floor, the activity of radon would decrease with time. The half-life of radon-222 is 3.82 days and after this period, the activity will be 100 Becquerel. After another 3.82 days, the activity will be 50 Becquerel, and so on.

We wish to determine how long it takes before the activity has decreased to 10 Becquerel. Since we know the half-life, we begin by calculating the decay constant k by use of equation (3- 7):

$$k = \frac{\ln 2}{3.82 \text{ days}} = 0.181 \text{ days}^{-1}$$

Now we use equation (3- 6):

$$A(t) = A_0 \cdot \exp(-k \cdot t) \Rightarrow$$

$$10 \text{ Becquerel} = 200 \text{ Becquerel} \cdot \exp(-0.181 \text{ days}^{-1} \cdot t) \Rightarrow t = 16.6 \text{ days}$$

Thus, it takes 16.6 days before the activity of radon has decreased from 200 to 10 Becquerel if the cellar walls and floor were completely isolated and made impermeable to radon gas.

Example 3- H: Carbon-14 as a method to determine age

A method to determine age of old organic items is the carbon-14 method. This method is based on decay of radioactive carbon-14 isotope. Items found in the Lascaux-caves in France have a rate of decay of ¹⁴C nuclei of 2.25 pr. minute pr. gram carbon.

We wish to determine how old such items are. Half-life of ¹⁴C is 5730 years. In living organisms, 15.3 nuclei ¹⁴C decay pr. minute pr. grams of carbon. The decay is expressed as follows from equation (3- 6):

$$\ln\left(\frac{A}{A_0}\right) = -k \cdot t,$$

where k can be expressed from the half-life:

$$k = \frac{\ln 2}{t_{1/2}}$$

We hereby arrive at:

$$\ln\left(\frac{2.25}{15.3}\right) = -\left(\frac{\ln 2}{5730 \text{ years}}\right) \cdot t \Leftrightarrow t = 15846 \text{ years}$$

The items found in the Lascaux-caves in France thereby have an approximate age of almost 16,000 years.

3.6 Summing up on chapter 3

In this chapter we saw that the stoichiometry of a chemical reaction must be fulfilled on both the right and the left side of a reaction arrow when a chemical reaction is written. Expressions for rate of reactions were defined and we saw that rate of reactions are not always constant but often decreases with time. It was seen how the change of reactant concentration depend upon the reaction order. Expressions for 0th, 1st, and 2nd order reactions were derived, and the importance of temperature was highlighted via the introduction of the Arrhenius-equation. Catalysts were briefly introduced as compounds that increase the rate of reaction by lowering the energy of activation without being used itself. Lastly, we saw how kinetics of radioactive decay in many ways is similar to the kinetics of other chemical reactions. We looked at half-life and activity and saw how radioactive decay can be used to determine age of old organic items.



www.job.oticon.dk

oticon
PEOPLE FIRST

4. Chemical equilibrium

Understanding the principle of chemical equilibrium is the key to understanding chemistry! In this section we shall look at chemical equilibrium by focusing on solid compounds dissolved in water. We will start by introducing basic terms as solubility and solubility products; terms which are of great importance for many chemists and chemical engineers in their working life.

4.1 Solubility product

When a solid ionic compound is dissolved in water it is often taken for granted that the compound is completely dissolved into an anion and a cation. As an example, one can look at the dissolution of solid calcium fluoride in water:

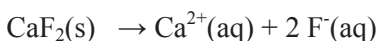

When CaF_2 is brought in contact with water, initially no Ca^{2+} and F^{-} is present in the water phase. As the dissolution proceeds, the concentration of Ca^{2+} and F^{-} increase to a certain level, being the equilibrium concentration. At the equilibrium concentration, the opposite reaction occurs as well with the same rate at the forward reaction. The opposite reaction is one where a calcium ion and two fluorides collide and form solid CaF_2 :

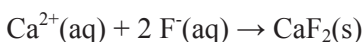

A dynamic equilibrium between the two reactions exists when the concentration of Ca^{2+} and F^{-} are at a certain level; the equilibrium concentration. This is represented by an arrow pointing in both directions:

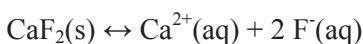

At equilibrium the aqueous solution is said to be saturated. If only a relatively small amount of calcium fluoride is dissolved, all of it will dissolve but if a larger amount is put in contact with water, equilibrium will be reached. At saturation, the product of the Ca^{2+} and F^{-} concentrations is a constant, being the *solubility product*:

$$K_{\text{sp}} = [\text{Ca}^{2+}] \times [\text{F}^{-}]^2 / [\text{CaF}_2] = [\text{Ca}^{2+}] \times [\text{F}^{-}]^2$$

$[\text{Ca}^{2+}]$ and $[\text{F}^{-}]$ are the concentrations of ions expressed in moles/L. K_{sp} is the *solubility product*. Note that the fluoride concentration is raised to the power of 2 which comes from the stoichiometric coefficient. Solid species, in this case CaF_2 , is included in the solubility product with its activity rather than the concentration; in the solid phase, the concentration is very high and, thus, it is more practical to use the activity. The activity of pure compounds (like solid CaF_2 in this case) equals 1 and, therefore, solid compounds in practice are not included in expressions for solubility products.

Example 4- A: Solubility of PbSO₄

We wish to calculate the solubility of lead sulphate (PbSO₄) at 25 °C in pure water. At 25 °C, PbSO₄ has a solubility product of $1.3 \times 10^{-8} \text{ M}^2$. When solid PbSO₄ dissolves, initially the system only contains PbSO₄(s) and H₂O. However, as time passes, lead sulphate will dissolve until lead ions and sulphate reach the equilibrium concentrations and the aqueous solution becomes saturated:

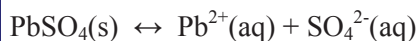

Similar to the CaF₂ example, the solubility product for lead sulphate is written as:

$$K_{\text{sp}} = [\text{Pb}^{2+}] \times [\text{SO}_4^{2-}] / [\text{PbSO}_4] = [\text{Pb}^{2+}] \times [\text{SO}_4^{2-}]$$

Again, note that solid lead sulphate is included in the solubility product with its activity rather than the concentration (which is the same as not including solid lead sulphate in the expression). To determine the solubility of PbSO₄ is the same as determining the equilibrium concentrations of Pb²⁺ and SO₄²⁻. In a situation, in which one does not know the initial concentrations of the involved species, we say that “*x*” moles/L of the solid species is to be dissolved in order to reach equilibrium:



By inserting *x* as the equilibrium concentrations in the expression for the solubility product K_{sp} , the solubility can be calculated:

$$1.3 \times 10^{-8} \text{ M}^2 = K_{\text{sp}} = [\text{Pb}^{2+}] \times [\text{SO}_4^{2-}] = x^2 \Leftrightarrow x = (K_{\text{sp}})^{1/2}$$

Thus, $x = 1.1 \times 10^{-4} \text{ M}$ and, therefore, the solubility of lead sulphate at 25 °C is $1.1 \times 10^{-4} \text{ moles/L}$.

It is important to distinguish between solubility of solid species and the solubility product. The solubility product is an equilibrium constant that only has one value at a certain temperature. The solubility, on the other hand, is an equilibrium position which depends upon other factors such as the presence of other ions. The solubility product and the solubility of ions do also have different units as seen in the example above. Therefore, solubilities and solubility products are not the same.

4.1.1 Relative solubility

When more than one solid compound is to be dissolved in the same solution, the solubility product, K_{sp} , gives important information about which compound will dissolve most easily. However, be aware! You can only compare solubility products when they have the same unit. We shall look at this in the following examples:

Example 4- B: Relative solubility; first example

We wish to determine the order of solubility of three solid species. In other words, we wish to investigate which of the three following species that are easiest to dissolve:

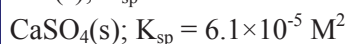
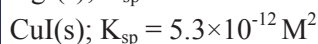
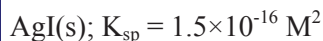

The three equilibrium situations reactions are given here:

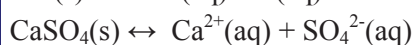
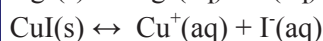
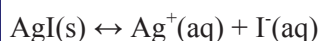

Or expressed more generally:

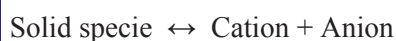

$$\text{Solubility product} = K_{\text{sp}} = [\text{Cation}] \times [\text{Anion}]$$

The unknown solubility is again expressed as “x”:

$$[\text{Cation}] = x \text{ mol/l}$$

$$[\text{Anion}] = x \text{ mol/l}$$

The solubility x can then be inserted into the solubility product:

$$K_{\text{sp}} = [\text{Cation}] \times [\text{Anion}] = x^2 \Leftrightarrow$$

$$x = K_{\text{sp}}^{1/2} = \text{solubility}$$

Thus, the values for the solubilities can be calculated:

$$\text{AgI(s)}; K_{\text{sp}} = 1.5 \times 10^{-16} \text{ M}^2 \Leftrightarrow \text{solubility} = 1.2 \times 10^{-8} \text{ M}$$

$$\text{CuI(s)}; K_{\text{sp}} = 5.3 \times 10^{-12} \text{ M}^2 \Leftrightarrow \text{solubility} = 2.3 \times 10^{-6} \text{ M}$$

$$\text{CaSO}_4\text{(s)}; K_{\text{sp}} = 6.1 \times 10^{-5} \text{ M}^2 \Leftrightarrow \text{solubility} = 7.8 \times 10^{-3} \text{ M}$$

CaSO_4 is thereby more dissolvable than CuI which then is more dissolvable than AgI . In this example, all three situations comprise two ions being dissolved each time a solid compound is dissolved, and the solubility products thus have the units (M^2). Therefore, you could have determined the order of solubility just by looking at the values of the solubility products. However, this is only possible when the units are the same! In the following example we will look at a situation where you can not determine the order of solubility just by looking at the values of the solubility products.

Example 4- C: Relative solubility; second example

We wish to determine the order of solubility for the following three solid species:

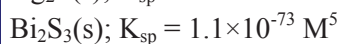
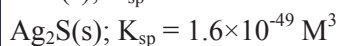
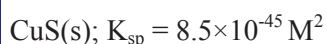

The three equilibrium reactions are given below:

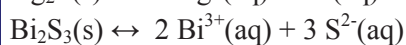
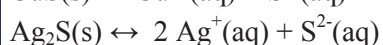
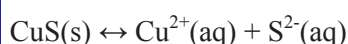

To determine the order of solubility, a direct comparison of the K_{sp} values can not be done since the units are different (M^2 , M^3 , and M^5). How do we then do? We set up the following table for the three equilibrium reactions:

Equilibrium reaction	K_{sp}	Solubility, x [moles/l]
$\text{CuS(s)} \leftrightarrow \text{Cu}^{2+}(\text{aq}) + \text{S}^{2-}(\text{aq})$ $x \qquad \qquad \qquad x$	x^2	$x = K_{sp}^{1/2} = 4.2 \times 10^{-23} \text{ M}$
$\text{Ag}_2\text{S(s)} \leftrightarrow 2 \text{Ag}^+(\text{aq}) + \text{S}^{2-}(\text{aq})$ $2x \qquad \qquad \qquad x$	$(2x)^2 \cdot x = 4x^3$	$x = (K_{sp}/4)^{1/3} = 3.4 \times 10^{-17} \text{ M}$
$\text{Bi}_2\text{S}_3\text{(s)} \leftrightarrow 2 \text{Bi}^{3+}(\text{aq}) + 3 \text{S}^{2-}(\text{aq})$ $2x \qquad \qquad \qquad 3x$	$(2x)^2 \cdot (3x)^3 = 108x^5$	$x = (K_{sp}/108)^{1/5} = 1.0 \times 10^{-15} \text{ M}$

Now that the solubilities have been determined, one sees that Bi_2S_3 is the most soluble of the three followed by Ag_2S . CuS is the most insoluble of the three compounds. This could not have been concluded just by looking at the solubility products since they did not have the same units!

4.1.2 Ion effects on solubility

So far we have only paid attention to ionic species and their solubility in pure water. In this section we shall look at how solubility is influenced when a solid is to be dissolved in a solution that already contains certain ions:

Example 4- D: Solubility and “foreign” ions

We wish to determine the solubility of silver chromate Ag_2CrO_4 in a 0.100 M aqueous solution of AgNO_3 . The equilibrium reaction is given below:



Silver chromate has the following solubility product:

$$K_{\text{sp}} = [\text{Ag}^+]^2 \times [\text{CrO}_4^{2-}] = 9.0 \times 10^{-12} \text{ M}^3$$

The solution, in which we are about to dissolve silver chromate, already contains Ag^+ and NO_3^- . As nitrate does not “participate” in the above equilibrium reaction, we ignore its presence since it does not influence the equilibrium. The initial concentration of Ag^+ is, however, important. We have the following initial concentrations of the “involved” ions:

$$[\text{Ag}^+]_0 = 0.100 \text{ M}$$

$$[\text{CrO}_4^{2-}]_0 = 0$$

Please click the advert



CHALLENGE YOURSELF

WWW.STUDYINSWEDEN.SE

Today's job market values ambitious, innovative, perceptive team players. Swedish universities foster these qualities through a forward-thinking culture where you're close to the latest ideas and global trends.

Si.
Swedish Institute

Whatever your career goals may be, studying in Sweden will give you valuable skills and a competitive advantage for your future. www.studyinsweden.se

Again, we use the x for the unknown solubility:



At equilibrium:

$$[\text{Ag}^+]_0 = [\text{Ag}^+]_0 + 2x = 0.100 \text{ M} + 2x \text{ M}$$

$$[\text{CrO}_4^{2-}] = [\text{CrO}_4^{2-}]_0 + x = 0 + x \text{ M}$$

These concentrations are inserted into the solubility product expression:

$$9.0 \times 10^{-12} \text{ M}^3 = [\text{Ag}^+]^2 \times [\text{CrO}_4^{2-}] = (0.100 + 2x)^2 \cdot x \Leftrightarrow$$

$$x = 9.0 \times 10^{-10} \text{ M}$$

Thus, the solubility of silver chromate is 9.0×10^{-10} mol/L in a 0.100 M AgNO_3 solution. If the solubility of silver chromate is to be found in pure water, the situation would have been:

$$9.0 \times 10^{-12} \text{ M}^3 = [\text{Ag}^+]^2 \times [\text{CrO}_4^{2-}] = (2x)^2 x \Leftrightarrow$$

$$x = 1.3 \times 10^{-4} \text{ M}$$

Therefore, 1.3×10^{-4} moles/L of $\text{Ag}_2\text{CrO}_4(\text{s})$ can be dissolved in pure water. Thus, one sees that the silver ions already present in the solution hinder the dissolution of silver chromate to a large extent.

4.2 Precipitation

So far we have been looking at the dissolution of solid species in aqueous solutions with or without an initial concentration of certain ions. In this section, the opposite situation will be looked upon; precipitation of solid material from an aqueous solution. The *ionic product*, defined in a similar manner as the solubility product, will be introduced. For the dissolution of CaF_2 into ions, the ionic product is defined as:

$$Q = [\text{Ca}^{2+}]_0 \times [\text{F}^-]_0^2 / [\text{CaF}_2] = [\text{Ca}^{2+}]_0 \times [\text{F}^-]_0^2$$

Again, note that solid compounds, CaF_2 , is inserted with a value of 1 in such an expressions since the activity in the solid phase equals 1 (if the compound is pure). Furthermore, one should note that ionic products and solubility products are not the same. Solubility products are constants at constant temperature, whereas ionic products just tell something about ionic concentrations at some given conditions; not necessarily at equilibrium. If we pour a solution of Ca^{2+} into a solution containing F^- , solid CaF_2 may be formed as precipitates depending on the concentrations of ions after mixing. In order to be able to predict precipitation, we will look at the relation between the solubility product and the ionic product. The units for these two products are identical, since they arise from the same reaction. Thus, the two products can be compared directly:

- If the ionic product, Q , is larger than the solubility product, K_{sp} , precipitation will occur and continue until the concentrations of remaining ions comprise an ionic product equal to the solubility product; $Q=K_{sp}$.
- If the ionic product, Q , is lower than the solubility product, K_{sp} , no precipitation will occur.

Example 4- E: Equilibrium concentration after precipitation

We wish to determine the equilibrium concentrations of Pb^{2+} and I^- after precipitation of PbI_2 from a mixture of 100.0 mL 0.0500 M $Pb(NO_3)_2$ and 200.0 mL 0.100 M NaI. Initially it must be determined whether or not solid PbI_2 will precipitate after mixing. The solubility product K_{sp} for PbI_2 is $1.4 \times 10^{-8} M^3$. We start by calculating the concentrations of Pb^{2+} and I^- after mixing:

$$[Pb^{2+}]_0 = \frac{0.100L \times 0.0500 mol/L}{0.100L + 0.200L} = 0.017M$$

$$[I^-]_0 = \frac{0.200L \times 0.100 mol/L}{0.100L + 0.200L} = 0.067M$$

The ion product of lead iodide is now calculated:

$$Q = [Pb^{2+}]_0 \times [I^-]_0^2 = 0.017M \times (0.067M)^2 = 7.4 \times 10^{-5} M^3$$

Since the ionic product is larger than the solubility product, precipitation of $PbI_2(s)$ will occur until equilibrium is reached. In order to determine the concentrations of Pb^{2+} and I^- ions after precipitations (thus at equilibrium), we set up a *before* and an *after* table showing the molecular concentrations before and at equilibrium:

	$Pb^{2+}(aq)$	+	$2 I^-(aq)$	\leftrightarrow	$PbI_2(s)$
Before precipitation	$[Pb^{2+}]_0$		$[I^-]_0$		The amount of precipitated matter will not affect the equilibrium
After precipitation (at equilibrium)	$[Pb^{2+}]_0 - x$		$[I^-]_0 - 2x$		

The concentrations at equilibrium is inserted in the expression for the solubility product:

$$K_{sp} = 1.4 \times 10^{-8} M^3 = ([Pb^{2+}] - x) \times ([I^-] - 2x)^2 \Leftrightarrow$$

$$x = 0.0167 M$$

Now the equilibrium concentrations can be calculated:

$$[Pb^{2+}]_{equilibrium} = 0.017M - 0.0167M = 1.3 \times 10^{-5} M$$

$$[I^-]_{equilibrium} = 0.067M + 2 \times 0.0167M \approx 3.3 \times 10^{-2} M$$

4.2.1 Selective precipitation

Solutions of metal ions are often separated by selective precipitation. One example is a solution containing Ba^{2+} as well as Ag^+ . If NaCl is added to the solution, only AgCl precipitates whereas Ba^{2+} continues to stay in the solution. We shall now look at a similar example.

Example 4- F: Selective precipitation

A solution contains $1.0 \times 10^{-4} \text{ M Cu}^+$ and $2.0 \times 10^{-3} \text{ M Pb}^{2+}$. We now imagine that we are able to add iodide without increasing the volume. Slowly, I^- is added. Will $\text{PbI}_2(\text{s})$ or CuI precipitate first? Or will they both precipitate until certain equilibrium concentrations are reached?

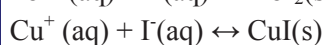
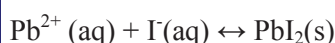

The K_{sp} values are $1.4 \times 10^{-8} \text{ M}^3$ for PbI_2 and $5.3 \times 10^{-12} \text{ M}^2$ for CuI . If PbI_2 should precipitate, the necessary iodide concentration would be:

$$K_{sp} = [\text{Pb}^{2+}] \times [\text{I}^-]^2 \Leftrightarrow [\text{I}^-] = \sqrt{\frac{K_{sp}}{[\text{Pb}^{2+}]}} = \sqrt{\frac{1.4 \times 10^{-8} \text{ M}^3}{2.0 \times 10^{-3} \text{ M}}} = 0.026 \text{ M}$$

Thus, a concentration of I^- above $2.6 \times 10^{-3} \text{ M}$ is required in order to make lead iodide precipitate from this solution. For CuI , the necessary iodide concentration is calculated in a similar way:

$$K_{sp} = [\text{Cu}^{2+}] \times [\text{I}^-] \Leftrightarrow [\text{I}^-] = \frac{K_{sp}}{[\text{Cu}^{2+}]} = \frac{5.3 \times 10^{-12} \text{ M}^2}{1.0 \times 10^{-4} \text{ M}} = 5.3 \times 10^{-8} \text{ M}$$

Thus, a concentration of I^- higher than $5.3 \times 10^{-8} \text{ M}$ will make $\text{CuI}(\text{s})$ precipitate. Therefore, if iodide is added slowly, $\text{CuI}(\text{s})$ will precipitate before $\text{PbI}_2(\text{s})$ from the given solution.

4.3 Summing up on chapter 4

The important concepts of ionic product, solubility product, and solubility equilibrium were introduced in this chapter. Through examples we saw how the solubility of different species can be calculated from solubility products. Furthermore, we saw how the relative solubility of solid species can be determined from solubility products.

An order of solubility of different solid species can be determined by looking at the solubility product ONLY when the numbers of ions are similar (meaning ONLY when the solubility products have the same unit)

We saw how the presence of foreign ions influences the solubility of solid species. Lastly, we looked at precipitation. We saw how the relationship between the ion product and the solubility product determines whether or not precipitation will occur.

Please click the advert

Always aiming for higher ground. Just another day at the office for a Tiger.

Join the Accenture High Performance Business Forum

On Thursday, April 23rd, Accenture invites top students to the High Performance Business Forum where you can learn how leading Danish companies are using the current economic downturn to gain competitive advantages. You will meet two of Accenture's global senior executives as they present new original research and illustrate how technology can help forward thinking companies cope with the downturn.

Visit student.accentureforum.dk to see the program and register

Visit student.accentureforum.dk

• Consulting • Technology • Outsourcing

accenture
High performance. Delivered.

© 2009 Accenture. All rights reserved.

5. Acids and bases

In this chapter we are going to look at the heart of chemistry being; acids and bases. We will look at their interactions and further develop the theory of equilibrium chemistry. We start by noting that acid/base chemistry always takes place in aqueous solutions; *acid strength* and *base strength* thus have only relevance in connection to aqueous solutions.

5.1 About acids and bases

Acid solutions are known from many types of foods. According to the Brønsted-Lowry definition, an acid is a proton donor (in terms of H^+ ions) while a base is a proton receiver. Water may act as an acid as well as act as a base. In an acid-base reaction, a H^+ ion is transferred from the acid to the base:

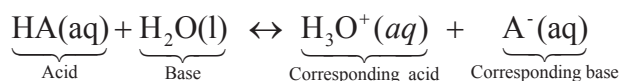

An acid is generally written as HA while the corresponding base is written as A^- . By transfer of the H^+ ion, the acid HA is converted to its corresponding base A^- . Thus, HA and A^- is a so-called *corresponding acid/base pair*.

5.1.1 Acid strength

The strength of an acid (in an aqueous solution) is defined from the equilibrium “position” for this general reaction:



An acid is known to be strong when the equilibrium is strongly shifted to the right, meaning that there is almost no HA left in the solution. On the contrary, the acid is known to be weak when there is almost no corresponding base A^- in the solution. When the acid is strong, the equilibrium arrow (in the written form of the chemical equilibrium reaction) may be replaced by a right-pointing arrow. However when the acid is weak, the equilibrium arrow must be written pointing both directions. An equilibrium expression for the general acid-base reaction is expressed in a similar way as in chapter 3 and chapter 4:

$$K_a = \frac{[H_3O^+][A^-]}{[HA]} = \frac{[H^+][A^-]}{[HA]}$$

The equilibrium constant K_a , in this case, is known as the acids *dissociation-constant* or simply the *strength-constant*. Similarly a dissociation-constant for bases K_b exists. We do not distinguish between H^+ and H_3O^+ ions, as long as one remembers that in aqueous solutions, H^+ always exist as H_3O^+ ions. As the percent-wise amount of water molecules by far dominates the amount of acid-base components, the mole fraction of water is close to one. Water takes part in the equilibrium expressions with its mole fraction which equals ~ 1 (like with solid compounds in the precious chapters). Similarly, corresponding to the considerations above, it is clear that for strong acids, the K_a values are large while K_a values are small for weak acids. As the K_a values vary a lot from acid to acid, one often chose to express the acid constant by means of the following logarithmic expression:

$$pK_a = -\log[K_a] \quad (5-1)$$

Based on this definition, strong acids has very small or even negative pK_a values while weak acids have larger pK_a values.

5.1.2 The pH-scale

Because the concentration of H^+ ions in solution generally is quite small, one has conveniently chosen to express a solutions acidness based on the well-known pH scale, completely analogous to the principles of how the acid constant K_a was expressed as an acid exponent pK_a :

$$pH = -\log[H^+] = -\log[H_3O^+] \quad (5-2)$$

Please click the advert





it's an **interesting** world

Get under the skin of it.

Graduate opportunities
Cheltenham | £24,945 + benefits

One of the UK's intelligence services, GCHQ's role is two-fold: to gather and analyse intelligence which helps shape Britain's response to global events, and, to provide technical advice for the protection of Government communication and information systems. In doing so, our specialists – in IT, internet, engineering, languages, information assurance, mathematics and intelligence – get well beneath the surface of global affairs. If you thought the world was an interesting place, you really ought to explore our world of work.

www.careersinbritishintelligence.co.uk

Applicants must be British citizens. GCHQ values diversity and welcomes applicants from all sections of the community. We want our workforce to reflect the diversity of our work.







This means that if a solution has a concentration of H^+ ions of e.g. $1.0 \cdot 10^{-7} \text{ M}$, the pH value of the solution is 7. Figure 5-1 gives the pH-scale as well as pH-values for well-known aqueous solutions.

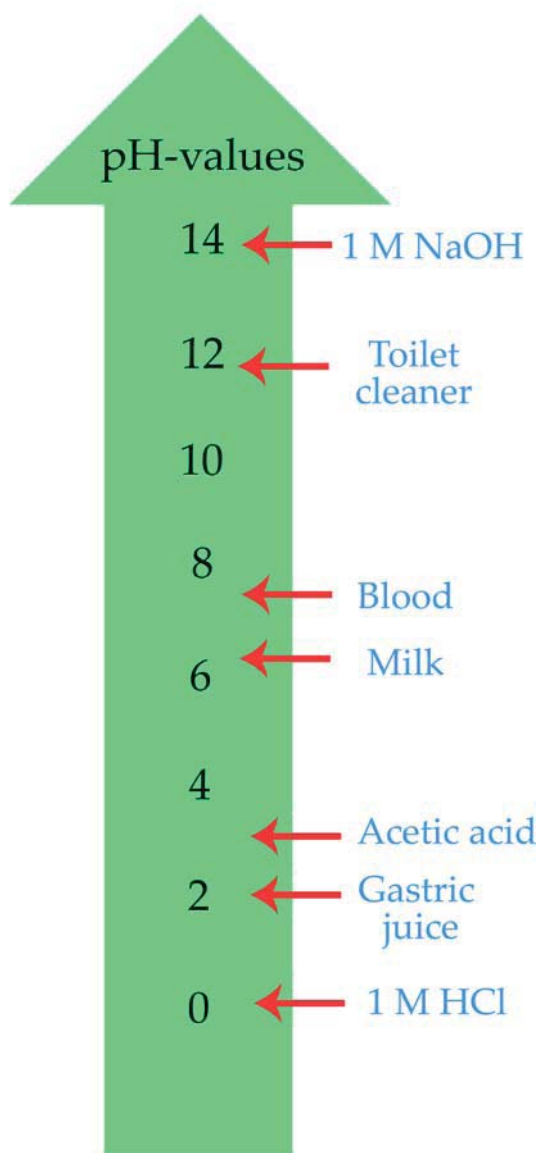
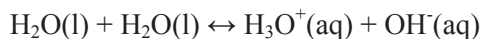

Figure 5- 1: The pH-scale
pH-values for well-known solutions.

As pH is a logarithmic scale, it means that e.g., a solution with a pH-value of 4 have a concentration of H^+ ions 10 times as high as a solution with a pH value of 5.

5.1.3 The autoprotolysis of water

As indicated earlier, water may function both as an acid and as a base. Such a property is often referred to as an *amfolyte*. This means that water may react with itself in the following reaction:



The equilibrium is “positioned” far to the left. The equilibrium constant for this specific equilibrium is referred to as K_w , having the following value:

$$K_w = 1.0 \times 10^{-14} \text{ M}^2$$

This means that only relatively few water molecules react to form H_3O^+ and OH^- ions. In pure neutral pH water, $[\text{H}_3\text{O}^+]$ equals $[\text{OH}^-]$ as the ions are produced in a 1:1 relation. At a temperature of 25 °C in pure water:

$$[\text{H}_3\text{O}^+] = [\text{OH}^-] = 1.0 \times 10^{-7} \text{ M}$$

Therefore, neutral pH water has a pH value of 7.0 and the concentrations of H_3O^+ and OH^- are both $1.0 \times 10^{-7} \text{ M}$.

5.2 pH calculations

In the following section we will look at methods for calculating pH values in a number of different solutions.

Please click the advert



CHALLENGE YOURSELF

WWW.STUDYINSWEDEN.SE

Si.
Swedish Institute

Today's job market values ambitious, innovative, perceptive team players. Swedish universities foster these qualities through a forward-thinking culture where you're close to the latest ideas and global trends.

Whatever your career goals may be, studying in Sweden will give you valuable skills and a competitive advantage for your future. www.studyinsweden.se

5.2.1 Calculation of pH in strong acid solutions

Calculations of pH in solutions are closely connected with equilibrium considerations (described in the previous chapter):

Example 5- A: pH calculation in a strong acid (hydrochloric acid)

A solution consists of 0.5 M HCl. We know that HCl is a strong acid which is why it is reasonable to assume that the acid is completely dissociated, meaning that the following reaction is completely “pushed” to the right:

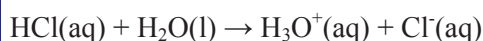

We neglect, as it is often the case, the contribution to the concentration of H_3O^+ from autoprotolysis of water, and assume that all HCl molecules are dissociated:

$$[\text{H}_3\text{O}^+] = 0.5 \text{ M}$$

Now the pH value is calculated as:

$$\text{pH} = -\log[\text{H}_3\text{O}^+] = -\log[0.5] = 0.3$$

5.2.2 Calculation of pH in weak acid solutions

As mentioned earlier, it is necessary to account for the “position” of the equilibrium reaction in the case of weak acids. As the following example illustrates, one has to proceed in steps when pH is to be calculated in weak acid solutions.

Example 5- B: pH calculation in weak acid solution

A solution consists of 1.0 M HF. HF has a K_a value of 7.2×10^{-4} M and we thereby have a weak acid solution. We wish to calculate the pH-value of the solution.

The first step is to write the most important components in the solution:



Then we write the aqueous equilibrium reaction:

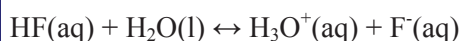

We return to the equilibrium expression:

$$K_a = 7.2 \times 10^{-4} \text{ M} = \frac{[\text{H}_3\text{O}^+][\text{F}^-]}{[\text{HF}]}$$

Analogously to prior examples, we now pay attention to initial and equilibrium conditions. The initial concentrations are:

$$[\text{HF}]_0 = 1,0 \text{ M}$$

$$[\text{F}^-]_0 = 0 \text{ M}$$

$$[\text{H}_3\text{O}^+]_0 = 10^{-7} \text{ M (from the autoprotolysis of water)}$$

The end-concentrations are unknown, indicated by a “ x ” (as in chapter 4):

$$[\text{HF}] = (1,0 - x) \text{ M}$$

$$[\text{F}^-] = x \text{ M}$$

$$[\text{H}_3\text{O}^+] = (10^{-7} + x) \text{ M}$$

This gives the following equation:

$$K_a = 7.2 \times 10^{-4} \text{ M} = \frac{(10^{-7} + x) \cdot x}{1,0 - x} \Rightarrow x = 2.6 \times 10^{-2} \text{ M}$$

Thereby, $[\text{H}_3\text{O}^+] = 2.6 \times 10^{-2}$ M. pH is now calculated:

$$\text{pH} = -\log[\text{H}_3\text{O}^+] = -\log(2.6 \times 10^{-2}) = 1.6$$

It may be seen from the calculations that the contribution to the H_3O^+ concentration coming from the autoprotolysis of water is negligible compared to the calculated x . Thus, the contribution from the autoprotolysis of water may in practise be omitted when x is in the range of 10^{-5} mol/L or larger.

5.2.3 Calculation of pH in mixtures of weak acids

Sometimes a solution contains a mixture of two weak acids with different acid strengths. Calculations of pH in such solutions require some additional considerations. This will be illustrated in the following example:

Example 5- C: pH in a solution with two weak acids

We wish to determine pH in a solution containing 1.00 M HCN and 5.00 M HNO₂. The K_a value for HCN is 6.2×10^{-10} M while the K_a value is 4.0×10^{-4} M for HNO₂. As both acids are weak acids, and thereby only partly dissociates, the primarily species in the solution are:

HCN, HNO₂ and H₂O

Please click the advert



Brain power

By 2020, wind could provide one-tenth of our planet's electricity needs. Already today, SKF's innovative know-how is crucial to running a large proportion of the world's wind turbines.

Up to 25 % of the generating costs relate to maintenance. These can be reduced dramatically thanks to our systems for on-line condition monitoring and automatic lubrication. We help make it more economical to create cleaner, cheaper energy out of thin air.

By sharing our experience, expertise, and creativity, industries can boost performance beyond expectations. Therefore we need the best employees who can meet this challenge!

The Power of Knowledge Engineering

Plug into The Power of Knowledge Engineering.
Visit us at www.skf.com/knowledge



Download free books at BookBooN.com

The following primary reactions may be written as:



HNO_2 is a far stronger acid than HCN (these can be directly compared as the K_a 's have the same unit). We will assume that this acid is the dominating contributor to H^+ ions in the solution. We will thereby focus only on this equilibrium because the K_a of HCN is six orders of magnitudes lower than the value of HNO_2 :



$$K_a = 4.0 \times 10^{-4} \text{ M} = \frac{[\text{H}^+] \cdot [\text{NO}_2^-]}{[\text{HNO}_2]}$$

We now look at initial and equilibrium conditions, similar to other examples. The initial concentrations are:

$$[\text{HNO}_2]_0 = 5.00 \text{ M}$$

$$[\text{NO}_2^-]_0 = 0 \text{ M}$$

$$[\text{H}^+]_0 = 10^{-7} \text{ M (from autoprotolysis of water)}$$

and the end-concentrations are thereby:

$$[\text{HNO}_2]_0 = (5.00 - x) \text{ M}$$

$$[\text{NO}_2^-]_0 = x \text{ M}$$

$$[\text{H}^+]_0 = (10^{-7} + x) \text{ M}$$

which by insertion in the expression for K_a gives:

$$K_a = 4.0 \times 10^{-4} \text{ M} = \frac{(10^{-7} + x) \cdot x}{5.00 - x} \Rightarrow x = 4.5 \times 10^{-2} \text{ M}$$

The concentration of H^+ ions is then $4.5 \times 10^{-2} \text{ M}$ which gives a pH value of:

$$\text{pH} = -\log[4.5 \times 10^{-2}] = 1.35$$

Once again we see that the contribution to the H_3O^+ concentration from the autoprotolytic contribution of water is negligible compared to the calculated x -value which is why this contribution of 10^{-7} M in practice may be omitted.

5.3 Polyprotic acids

Some acids, such as H_3SO_4 and H_3PO_4 , may provide more than one H^+ ion. Such acids are called polyprotic acids and these provide their H^+ ions in steps; one proton at the time. For each step it is possible to determine a K_a value. The diprotic acid H_2CO_3 provide its two protons in the following two steps:

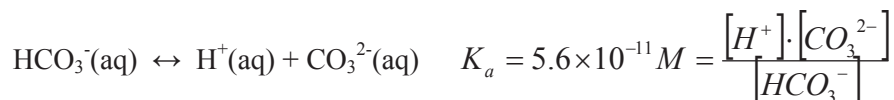
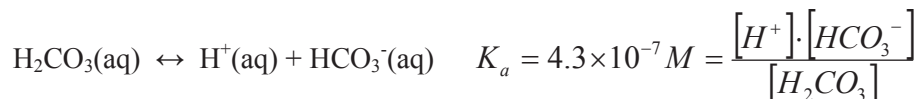

Please note how the corresponding base from the first step (hydrogen carbonate, HCO_3^-) acts at the acid in the second. As mentioned earlier, such a property is characteristic for an amfolyte. We shall see in the example below how pH may be calculated, when we have a solution of a polyprotic acid.

Trust and responsibility

NNE and Pharmaplan have joined forces to create NNE Pharmaplan, the world's leading engineering and consultancy company focused entirely on the pharma and biotech industries.

Inés Aréizaga Esteva (Spain), 25 years old
Education: Chemical Engineer

– You have to be proactive and open-minded as a newcomer and make it clear to your colleagues what you are able to cope. The pharmaceutical field is new to me. But busy as they are, most of my colleagues find the time to teach me, and they also trust me. Even though it was a bit hard at first, I can feel over time that I am beginning to be taken seriously and that my contribution is appreciated.

Please click the advert



NNE Pharmaplan is the world's leading engineering and consultancy company focused entirely on the pharma and biotech industries. We employ more than 1500 people worldwide and offer global reach and local knowledge along with our all-encompassing list of services.

nnepharmaplan.com

nne pharmaplan®

Example 5- D: pH in a solution of polyprotic acid

We wish to determine the pH value in a 5.0 M H_3PO_4 solution. H_3PO_4 is a tri-protic acid being semi-strong in the first step. In the first case we will assume that the dominating components in the solution are:



and initially the dominating equilibrium reaction is:

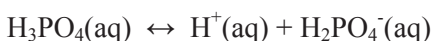

The corresponding equilibrium expression is:

$$K_{a1} = 7.5 \times 10^{-3} \text{ M} = \frac{[\text{H}^+] \cdot [\text{H}_2\text{PO}_4^-]}{[\text{H}_3\text{PO}_4]}$$

We will now look at the initial and equilibrium conditions. The initial concentrations are:

$$[\text{H}_3\text{PO}_4]_0 = 5.0 \text{ M}$$

$$[\text{H}_2\text{PO}_4^-]_0 = 0 \text{ M}$$

$$[\text{H}^+]_0 \approx 10^{-7} \text{ M (from the autoprotolysis of water)}$$

and the end-concentrations are:

$$[\text{H}_3\text{PO}_4] = (5.0 - x) \text{ M}$$

$$[\text{H}_2\text{PO}_4^-] = x \text{ M}$$

$$[\text{H}^+] = (10^{-7} + x) \text{ M}$$

which by insertion into the expression for K_a gives:

$$K_{a1} = 7.5 \times 10^{-3} = \frac{[\text{H}^+] \cdot [\text{H}_2\text{PO}_4^-]}{[\text{H}_3\text{PO}_4]} = \frac{(10^{-7} + x) \cdot x}{5.0 - x} \Rightarrow x = 0.19 \text{ M}$$

The concentrations of H^+ ions is 0.19 M which gives a pH of:

$$\text{pH} = -\log[0.19] = 0.72$$

So far we have assumed that it is only the first step that contributes significantly to the H_3O^+ concentration. In order to verify that the second and third step do not contribute to the H_3O^+ concentration, it is necessary with additional calculations of $[\text{HPO}_4^{2-}]$ and $[\text{PO}_4^{3-}]$ from the second and

from the third step of the equilibrium.

The concentration of HPO_4^{2-} is be found in from the following:

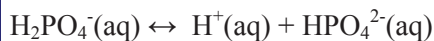

$$K_{a2} = 6.2 \times 10^{-8} \text{ M} = \frac{[\text{H}^+] \cdot [\text{HPO}_4^{2-}]}{[\text{H}_2\text{PO}_4^-]}$$

where:

$[\text{H}^+] \approx [\text{H}_2\text{PO}_4^-] = 0.19 \text{ M}$ (because the second K_a is so much smaller than the first one - and the autoprotolysis of water is neglected) \rightarrow

$$[\text{HPO}_4^{2-}] = K_{a2} = 6.2 \times 10^{-8} \text{ M}$$

In order to calculate $[\text{PO}_4^{3-}]$ we use the third equilibrium step:



$$K_{a3} = 4.8 \times 10^{-13} \text{ M} = \frac{[\text{H}^+] \cdot [\text{PO}_4^{3-}]}{[\text{HPO}_4^{2-}]} \approx \frac{0.19 \text{ M} \cdot [\text{PO}_4^{3-}]}{6.2 \cdot 10^{-8} \text{ M}} \Leftrightarrow [\text{PO}_4^{3-}] = 1.6 \times 10^{-19} \text{ M}$$

It is seen from the equilibrium expressions that the concentrations of H_3O^+ and HPO_4^{2-} , respectively, are taken simply from the calculations in the first and second step. From the calculated values of $[\text{HPO}_4^{2-}]$ and $[\text{PO}_4^{3-}]$, both being very small, it is reasonable to neglect these two acid contribution to the pH value of the solution. Thus, the pH value of 0.72 could be calculated solely from the first step.

5.4 Acid properties of salts

Some salts exhibit properties making solutions acid when the salt is dissolved in water. E.g., the following reaction takes place when NH_4Cl is dissolved in water:

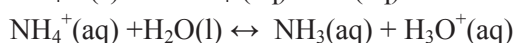

The last reaction is an acid-base reaction and we shall look at how pH is calculated in such a solution in the following example:

Example 5- E: pH in a solution of aluminium chloride

We wish to determine pH in a 0.01 M solution of AlCl_3 . It has been observed that when alumina chloride is dissolved in water, an acid solution is the outcome. Even though the Al^{3+} ion is not an acid itself, as it cannot produce a H^+ ion, it is the so-called hydrate compound $\text{Al}(\text{H}_2\text{O})_6^{3+}$ that is a weak acid reacting with water in the following reaction:



The Al^{3+} ion is in aqueous solution surrounded by six water molecules. The K_a value for $\text{Al}(\text{H}_2\text{O})_6^{3+}$ is 1.4×10^{-5} M. Again, we will start by looking at the main components in the solution:

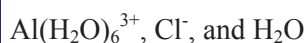

The equilibrium expression is written below:

$$K_a = 1.4 \times 10^{-5} \text{ M} = \frac{[\text{H}_3\text{O}^+] \cdot [\text{Al}(\text{OH})(\text{H}_2\text{O})_5^{2+}]}{[\text{Al}(\text{H}_2\text{O})_6^{3+}]}$$

We will now look at start and equilibrium conditions, completely analogous to prior examples. The initial concentrations are:

$$\begin{aligned} [\text{Al}(\text{H}_2\text{O})_6^{3+}]_0 &= 0.01 \text{ M} \\ [\text{Al}(\text{OH})(\text{H}_2\text{O})_5^{2+}]_0 &= 0 \text{ M} \\ [\text{H}_3\text{O}^+]_0 &= 10^{-7} \text{ M (from the autoprotolysis of water)} \end{aligned}$$

and the end concentrations:

$$\begin{aligned} [\text{Al}(\text{H}_2\text{O})_6^{3+}] &= (0.01 - x) \text{ M} \\ [\text{Al}(\text{OH})(\text{H}_2\text{O})_5^{2+}] &= x \text{ M} \\ [\text{H}_3\text{O}^+] &= (10^{-7} + x) \text{ M} \end{aligned}$$

Insertion in the expression for K_a :

$$K_a = 1.4 \times 10^{-5} \text{ M} = \frac{[\text{H}_3\text{O}^+] \cdot [\text{Al}(\text{OH})(\text{H}_2\text{O})_5^{2+}]}{[\text{Al}(\text{H}_2\text{O})_6^{3+}]} = \frac{(10^{-7} + x) \cdot x}{0.01 - x} \Rightarrow x = 3.7 \times 10^{-4} \text{ M}$$

Thus, the concentrations of H_3O^+ ions is 3.7×10^{-4} M. pH is calculated:

$$\text{pH} = -\log[3.7 \times 10^{-4}] = 3.4$$

Again we have included the contribution to the H_3O^+ concentration for the autoprotolysis of water, even though it is negligible, in this case, compared to the calculated x -value.

5.4 Ion effects on pH

In previous chapters, we have seen how the presence of “foreign ions” may influence equilibrium reactions. In this section we will see how the presence of H_3O^+ ions influences pH. We will look at a solution containing not just a weak acid (in general presented as HA) but also contains its salt (in general denoted as NaA). Even though it may seem as if we now have a completely new type of problem, we can solve it analogously to other examples in this chapter:

Please click the advert

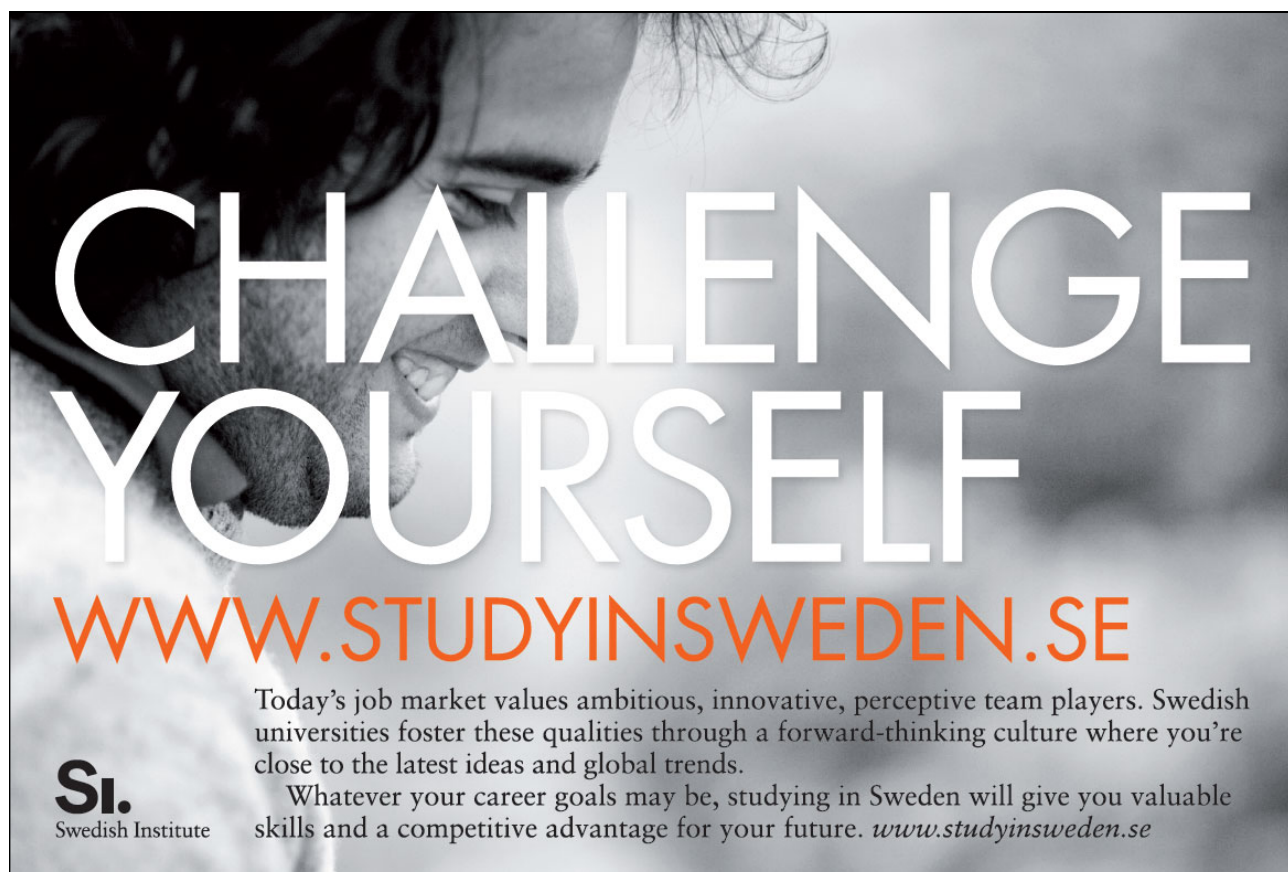

CHALLENGE YOURSELF

WWW.STUDYINSWEDEN.SE

Today's job market values ambitious, innovative, perceptive team players. Swedish universities foster these qualities through a forward-thinking culture where you're close to the latest ideas and global trends.

Whatever your career goals may be, studying in Sweden will give you valuable skills and a competitive advantage for your future. www.studyinsweden.se

Si.
Swedish Institute

Download free books at BookBooN.com

Example 5- F: pH in a solution of “foreign ions”

In Example 5-B we have found that the concentration of H_3O^+ ions in a 1.0 M solution of HF is 2.6×10^{-2} M. Thus, the degree of dissociation is 2.6 %, in this case. We wish to determine pH in a solution containing 1.0 M HF as well as 1.0 M NaF. The K_a value for HF is 7.2×10^{-4} M. The following components govern pH in the solution:

HF and F^-

We wish to determine the position of the following equilibrium:

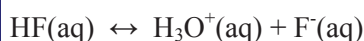

The equilibrium expression:

$$K_a = 7.2 \times 10^{-4} \text{ M} = \frac{[\text{H}_3\text{O}^+] \cdot [\text{F}^-]}{[\text{HF}]}$$

We will now look at the initial and equilibrium conditions. The initial concentrations are:

$$[\text{HF}]_0 = 1.0 \text{ M}$$

$$[\text{F}^-]_0 = 1.0 \text{ M (from the dissolved NaF)}$$

$$[\text{H}_3\text{O}^+]_0 = 10^{-7} \text{ M (from the autoprotolysis of water)}$$

and the end concentrations:

$$[\text{HF}] = (1.0 \text{ M} - x) \text{ M}$$

$$[\text{F}^-] = (1.0 + x) \text{ M}$$

$$[\text{H}_3\text{O}^+] = (10^{-7} + x) \text{ M}$$

Insertion into the expression of K_a :

$$K_a = 7.2 \times 10^{-4} \text{ M} = \frac{(10^{-7} + x) \cdot (1.0 + x)}{1.0 - x} \Rightarrow x = 7.2 \times 10^{-4} \text{ M}$$

Thus, the concentration of H_3O^+ is 7.2×10^{-4} M. Now pH is calculated:

$$\text{pH} = -\log[7.2 \times 10^{-4}] = 3.1$$

Again, the contribution from autoprotolysis of water is included in these calculations, even though it may in practice be neglected, in this case, since x is so much larger.

5.5 Buffer

One of the most important applications of the acid-base chemistry is the *buffer* concept. A buffer solution is a solution that counteracts an external “action” affecting pH. Some of the most well-known buffer solutions are found in the human body; they help to protect the pH of the blood from “external actions” and to keep the blood at a constant pH level. It is essential for the human body to be able to maintain a pH in the blood at fairly constant levels as certain types of cells only survive in a narrow pH range.

A buffer solution may contain a weak acid and its salt or a weak base and its salt. Examples of buffer solutions are e.g. HF / NaF, and NH₃ / NH₄Cl. Thereby, a buffer solution always consists of a weak acid and its corresponding weak base in comparable concentrations (concentrations close to each other).

5.5.1 The Buffer equation

By knowing an acids strength exponent pK_a, it is also possible to calculate pH in a buffer solution; this is the subject for the following section. We have the following general acid-base reaction:

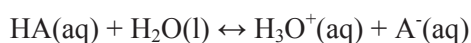

The equilibrium expression for this acid-base reaction is expressed as:

$$K_a = \frac{[\text{H}_3\text{O}^+] \cdot [\text{A}^-]}{[\text{HA}]}$$

The equation for K_a is rewritten by means of the natural logarithm; the *buffer equation* arises:

$$\text{pH} = \text{pK}_a - \log \frac{[\text{HA}]}{[\text{A}^-]} \quad (5-3)$$

The buffer equation is also known as the *Henderson-Hasselbalch equation*. When using the buffer equation, one must remember that HA and A⁻ denotes the corresponding acid-base pair and that pK_a is the acid exponent of the acid (HA). In the following example, the buffer effect is illustrated in a buffer system consisting of equal amounts of acetic acid and acetate into which strong base is added.

Example 5- G: pH in a buffer solution

A buffer solution consists of 0.5 M acetic acid CH_3COOH (K_a value of 1.8×10^{-5} M) and 0.5 M sodium acetate CH_3COONa . Thus, the solution consists of a weak acid (acetic acid) and its corresponding weak base (acetate). As the amounts of the weak acid and weak base are in the same order of magnitude (in this case they are actually equal), we have a buffer system. By use of the buffer equation, pH is calculated:

$$\text{pH} = \text{p}K_a - \log \frac{[\text{CH}_3\text{COOH}]}{[\text{CH}_3\text{COO}^-]} = \text{p}K_a - \log \left(\frac{0.5 \text{ M}}{0.5 \text{ M}} \right) = \text{p}K_a = 4.74$$

We wish to illustrate the buffer effect of the buffer system by calculating the pH change when 0.01 moles of solid NaOH is added to 1.0 litre of the buffer solution. As NaOH is a strong base, we assume that NaOH dissociate completely. The following components determine pH:

CH_3COOH , Na^+ , CH_3COO^- , OH^- , and H_2O

As the solution contains a large amount of strong base, OH^- , the following reaction will proceed completely:

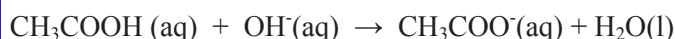

It is a good idea to divide the problem into two parts; first we assume that the reaction above reacts completely to the right, and secondly; we will perform equilibrium calculations of the buffer system:

	$\text{CH}_3\text{COOH}(\text{aq})$	+	$\text{OH}^-(\text{aq})$	\rightarrow	$\text{CH}_3\text{COO}^-(\text{aq})$	+	$\text{H}_2\text{O}(\text{l})$
Prior to reaction:	$1.0 \text{ L} \times 0.5 \text{ mol/L} = 0.5 \text{ mol}$		0.01 mol		$1.0 \text{ L} \times 0.5 \text{ mol/L} = 0.5 \text{ mol}$		
After reaction:	$0.5 \text{ mol} - 0.01 \text{ mol}$		0 mol		$0.5 \text{ mol} + 0.01 \text{ mol} = 0.51 \text{ mol}$		

Now the problem can be treated as an equilibrium problem. We will now look at initial and equilibrium conditions. The “initial” concentrations are (after reaction with strong base, of course):

$$[\text{CH}_3\text{COOH}]_0 = 0.49 \text{ M}$$

$$[\text{CH}_3\text{COO}^-]_0 = 0.51 \text{ M}$$

$$[\text{H}_3\text{O}^+]_0 \approx 0 \text{ (the autoprotolysis of water is neglected)}$$

And the final concentrations are:

$$[\text{CH}_3\text{COOH}] = (0.49 - x) \text{ M}$$

$$[\text{CH}_3\text{COO}^-] = (0.51 + x) \text{ M}$$

$$[\text{H}_3\text{O}^+] = x \text{ M}$$

Insertion into the expression for K_a :

$$K_a = 1.8 \times 10^{-5} \text{ M} = \frac{[\text{H}_3\text{O}^+] \cdot [\text{CH}_3\text{COO}^-]}{[\text{CH}_3\text{COOH}]} = \frac{x \cdot (0.51 + x)}{(0.49 - x)} \Rightarrow x = 1.7 \times 10^{-5} \text{ M}$$

The concentration of H_3O^+ ions is thus $1.7 \times 10^{-5} \text{ M}$. pH is calculated:

$$\text{pH} = -\log[1.7 \times 10^{-5}] = 4.76$$

The pH value could also have been calculated by use of the buffer equation since we have a buffer system with a weak corresponding acid-base pair with concentrations in the same order of magnitude (x is very small in this case):

$$[\text{CH}_3\text{COOH}] = (0.49 - x) \text{ M} \approx 0.49 \text{ M}$$

$$[\text{CH}_3\text{COO}^-] = (0.51 + x) \text{ M} \approx 0.51 \text{ M}$$

$$\text{pH} = \text{p}K_a - \log \left[\frac{[\text{CH}_3\text{COOH}]}{[\text{CH}_3\text{COO}^-]} \right] = 4.74 - \log \left(\frac{0.49 \text{ M}}{0.51 \text{ M}} \right) = 4.76$$

pH has thus changed from 4.74 to 4.76 (only 0.02 pH units) by addition of 0.010 moles solid NaOH to 1 litre of the buffer solution. This is what is meant by buffer capacity; addition of (in this case) a strong base does not really affect pH whereas the pH change is huge if the base is added to 1 litre of pure water:

We add the same amount of NaOH to 1.0 L of pure water and we calculate the pH change. In this case the concentration of OH^- ions is therefore 0.01 M. The concentration of H_3O^+ ions is now calculated from K_w :

$$K_w = 1.0 \times 10^{-14} \text{ M}^2 = [\text{H}_3\text{O}^+] \cdot [\text{OH}^-] \Rightarrow [\text{H}_3\text{O}^+] = \frac{1.0 \cdot 10^{-14} \text{ M}^2}{0.01 \text{ M}} = 1.0 \times 10^{-12} \text{ M}$$

pH is calculated:

$$\text{pH} = -\log[1.0 \times 10^{-12}] = 12.0$$

Thus, a change of 5 pH units (compared to the 0.02 pH unit change with the buffer solution) as pure water has a pH value of 7.0.

The buffer capacity can also be illustrated by addition of an equivalent amount of strong acid to the same type of buffer solution:

Example 5- H: Buffer capacity

We wish to calculate the pH change when 0.01 moles of HCl gas is absorbed in 1.0 L of a solution consisting of 5.00 M CH_3COOH and 5.00 M CH_3COONa .

Acetic acid has a pK_a value of 4.74. In this case, $[\text{CH}_3\text{COOH}]$ equals $[\text{CH}_3\text{COO}^-]$ before HCl is absorbed. Since we are dealing with a weak acid-base pair in equal concentrations, pH is calculated by use of the buffer equation:

$$\text{pH} = \text{pK}_a - \log \frac{[\text{CH}_3\text{COOH}]}{[\text{CH}_3\text{COO}^-]} = 4.74 - \log \left(\frac{5.00 \text{ M}}{5.00 \text{ M}} \right) = 4.74$$

After the addition of HCl, the important components in respect to pH are:

CH_3COOH , Na^+ , CH_3COO^- , H_3O^+ , Cl^- , and H_2O

Due to the addition of HCl, the following reaction occurs:

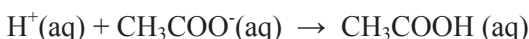

We assume that the components react completely, as H_3O^+ is a strong acid. We will look at the initial and equilibrium conditions. The initial concentrations are:

$$[\text{CH}_3\text{COOH}]_0 = 5.00 \text{ M}$$

$$[\text{CH}_3\text{COO}^-]_0 = 5.00 \text{ M}$$

$$[\text{H}_3\text{O}^+]_0 = 0.01 \text{ M} \text{ (the autoprotolysis of water is neglected)}$$

and the final concentrations are:

$$[\text{CH}_3\text{COOH}] = 5.00 \text{ M} + 0.01 \text{ M} = 5.01 \text{ M}$$

$$[\text{CH}_3\text{COO}^-] = 5.00 \text{ M} - 0.01 \text{ M} = 4.99 \text{ M}$$

$$[\text{H}_3\text{O}^+] = 0.01 \text{ M} - 0.01 \text{ M} = 0 \text{ M}$$

We still have a buffer system as the corresponding weak acid-base pair is present in amounts of the same magnitude. Thus, pH is calculated using the buffer equation:

$$\text{pH} = \text{pK}_a - \log \frac{[\text{CH}_3\text{COOH}]}{[\text{CH}_3\text{COO}^-]} = 4.74 - \log \frac{5.01}{4.99} \approx 4.74$$

This, in other words, means that the pH of the solution more or less has not changed even though HCl has been absorbed. This, again, clearly shows the concept of buffer capacity.

We saw in the previous two examples how buffer systems dampen external pH actions. In example 5-G, the initial concentration is 10 times lower than in example 5-H. This means that by addition of equivalent amounts of H^+ and OH^- , the change in pH is different. The larger the initial concentration of the buffer components are, the less pH will change by addition of equivalent amounts of strong acid and strong base, respectively. In other words, the buffer capacity of the solution increases with the concentration of the buffer components.

5.5.2 Buffer capacity

The buffer capacity is defined by the amounts of OH^- or H_3O^+ that the solution is able to “receive” without causing a major change in pH. A buffer with a large buffer capacity contains large concentrations of buffer components and may thereby be able to receive large amounts of OH^- or H_3O^+ without causing a significant change in pH. In general, pH in a buffer solution is determined by the $[\text{A}^-]/[\text{HA}]$ relation and the buffer capacity is determined by the sizes of $[\text{A}^-]$ and $[\text{HA}]$.

5.6 Titrations and pH curves

Titration is often used to analyse and determine the amount of acid and base in a solution. The principle is to continuously add a solution with a known concentration to the solution with an unknown concentration. The point of equivalence is often visualized by a colour shift from an indicator added prior to the titration. The pH profile of the titration is often depicted by plotting the pH of the solution as a function of the added amount of acid or base:

Please click the advert

MILKROUND SYSTEM
Become a business star with internships, placements, graduate jobs & schemes from leading companies.
www.milkround.com

PLANET CAREER ADVICE
Inhabited by insights into business careers and orbited by application advice.

FIRST CONTACT
Get matched to top business employers via intelligent emails landing in your inbox.

Milkround.com: rated the #1 graduate recruitment website in the UK Graduate Careers Survey 2009 of 16,000 university finalists.

Milkround.com

Example 5- I: Titration of weak acid with strong base

We have seen earlier how calculations of pH in solutions with strong acid and strong base are relatively simple because strong acids and strong bases are completely dissociated. On the contrary, pH calculation in cases in which the titrated acid is weak is not as simple. In order to be able to calculate the concentration of H_3O^+ after addition of a given amount of strong base, it is necessary to look at the weak acids dissociation equilibrium. Calculations of a pH profile for titration of a weak acid with a strong base involve a series of buffer-related problems.

We look at the following problem: 50.0 mL 0.10 M CH_3COOH is titrated with 0.100 M NaOH. We wish to determine the pH profile during titration with the strong base. Acetic acid has a K_a value of 1.8×10^{-5} M (and, thus, a $\text{p}K_a$ value of 4.74).

Case 1: No NaOH is added (solution of weak acid)

We are to determine pH in a solution of a weak acid, in this case:



$$K_a = 1.8 \times 10^{-5} \text{ M} = \frac{[\text{H}_3\text{O}^+] \cdot [\text{CH}_3\text{COO}^-]}{[\text{CH}_3\text{COOH}]}$$

We now look at the initial and equilibrium concentrations, completely analogously to earlier examples. The initial concentrations are:

$$[\text{CH}_3\text{COOH}]_0 = 0.10 \text{ M}$$

$$[\text{CH}_3\text{COO}^-]_0 = 0 \text{ M}$$

$$[\text{H}_3\text{O}^+]_0 \approx 0 \text{ M} \text{ (the autoprotolysis of water is neglected)}$$

and the final concentrations are:

$$[\text{CH}_3\text{COOH}] = (0.10 - x) \text{ M}$$

$$[\text{CH}_3\text{COO}^-] = x \text{ M}$$

$$[\text{H}_3\text{O}^+] = x \text{ M}$$

Insertion into the K_a expression:

$$K_a = 1.8 \times 10^{-5} \text{ M} = \frac{[\text{H}_3\text{O}^+] \cdot [\text{CH}_3\text{COO}^-]}{[\text{CH}_3\text{COOH}]} = \frac{x \cdot x}{0.10 - x} \Rightarrow x = 1.3 \times 10^{-3} \text{ M}$$

pH is now calculated:

$$\text{pH} = -\log[\text{H}_3\text{O}^+] = -\log(1.3 \times 10^{-3}) = 2.87$$

Case 2: 10.0 mL 0.10 M NaOH solution has been added – buffer system

Now strong base is added to a weak acid. The following components react completely:

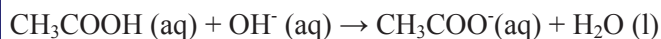

The initial and end-conditions are determined:

$$n(\text{CH}_3\text{COOH})_0 = 0.10 \text{ M} \times 50 \text{ mL} = 5 \text{ mmol}$$

$$n(\text{CH}_3\text{COO}^-)_0 = 0 \text{ mmol}$$

$$[\text{OH}^-]_0 = 0.10 \text{ M} \times 10 \text{ mL} = 1 \text{ mmol} \text{ (The autoprotolysis of water is neglected)}$$

The end-conditions are:

$$n(\text{CH}_3\text{COOH})_0 = 0.10 \times \text{M} \cdot 50 \text{ mL} = (5 - 1) \text{ mmol} = 4 \text{ mmol}$$

$$n(\text{CH}_3\text{COO}^-)_0 = 1 \text{ mmol}$$

$$[\text{OH}^-]_0 \approx 0 \text{ mmol} \text{ (The autoprotolysis of water is neglected)}$$

We now have a corresponding weak acid-base pair in comparable amounts. The pH value is determined using the buffer equation:

$$\text{pH} = \text{pK}_a - \log \frac{[\text{CH}_3\text{COOH}]}{[\text{CH}_3\text{COO}^-]} = \text{pK}_a - \log \frac{n(\text{CH}_3\text{COOH})}{n(\text{CH}_3\text{COO}^-)} = 4.74 - \log \frac{4}{1} = 4.14$$

Case 3: 25.0 mL 0.10 M NaOH solution has been added – buffer system

The procedure is completely analogous to case 2. The following reaction (running completely to the right) is once again written as follows:

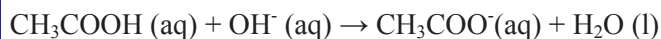

The initial conditions are:

$$n(\text{CH}_3\text{COOH})_0 = 0.10 \times \text{M} \cdot 50 \text{ mL} = 5 \text{ mmol}$$

$$n(\text{CH}_3\text{COO}^-)_0 = 0 \text{ mmol}$$

$$[\text{OH}^-]_0 = 0.10 \text{ M} \times 25 \text{ mL} = 2.5 \text{ mmol} \text{ (the autoprotolysis of water is neglected)}$$

The end conditions are:

$$n(\text{CH}_3\text{COOH})_0 = 0.10 \times \text{M} \cdot 50 \text{ mL} = (5 - 2.5) \text{ mmol} = 2.5 \text{ mmol}$$

$$n(\text{CH}_3\text{COO}^-)_0 = 2.5 \text{ mmol}$$

$$[\text{OH}^-]_0 \approx 0 \text{ mmol (the autoprotolysis of water is neglected)}$$

We still have a corresponding weak acid base pair present in the same amounts. Thus, pH is calculated by use of the buffer equation:

$$\text{pH} = \text{pK}_a - \log \frac{[\text{CH}_3\text{COOH}]}{[\text{CH}_3\text{COO}^-]} = \text{pK}_a - \log \frac{n(\text{CH}_3\text{COOH})}{n(\text{CH}_3\text{COO}^-)} = 4.74 - \log(1) = 4.74$$

We are now half way to the equivalence point. The original solution contained 50.0 mL of a 0.10 M CH_3COOH solution, corresponding to 5.0×10^{-5} mol CH_3COOH . Thus in this case, it takes 5.0×10^{-5} moles of OH^- before the equivalence point is reached. Half way towards the equivalence point, pH always equals the pK_a of the acid of the buffer system.

Case 4: 50.0 mL 0.10 M NaOH solution has been added – solution of a weak base

After the addition of 50.0 mL NaOH solution, we are at the point of equivalence which means that equal amounts of acetic acid and OH^- are present. This reaction runs completely:

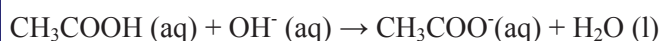

Acetic acid is now brought to its acetate form (CH_3COO^-). The problem is now to determine pH in a solution of a weak base with a concentration of 0.05 M (half of the initial concentration). The base equilibrium constant K_b is 5.6×10^{-10} M:



$$K_b = 5.6 \times 10^{-10} \text{ M} = \frac{[\text{OH}^-] \cdot [\text{CH}_3\text{COOH}]}{[\text{CH}_3\text{COO}^-]}$$

Once again we look at the initial conditions

$$[\text{CH}_3\text{COO}^-]_0 = 5.0 \times 10^{-3} \text{ mol} / (0.0500 \text{ L} + 0.0500 \text{ L}) = 5.0 \times 10^{-2} \text{ M}$$

$$[\text{OH}^-]_0 \approx 0 \text{ M (the autoprotolysis of water is neglected)}$$

$$[\text{CH}_3\text{COOH}]_0 = 0 \text{ M}$$

and the end conditions:

$$[\text{CH}_3\text{COOH}] = (5.0 \times 10^{-2} - x) \text{ M}$$

$$[\text{OH}^-] \approx x \text{ M}$$

$$[\text{CH}_3\text{COO}^-] = x \text{ M}$$

The equilibrium expression:

$$K_b = 5.6 \times 10^{-10} \text{ M} = \frac{x \cdot x}{0.050 - x} \Rightarrow x = 5.3 \times 10^{-6} \text{ M}$$

Thus, the concentration of OH^- is $5.3 \times 10^{-6} \text{ M}$. From K_w , $[\text{H}_3\text{O}^+]$ is calculated:

$$[\text{H}_3\text{O}^+] \cdot [\text{OH}^-] = K_w \Rightarrow [\text{H}_3\text{O}^+] = \frac{1.0 \times 10^{-14} \text{ M}^2}{5.3 \times 10^{-6} \text{ M}} = 1.9 \times 10^{-9} \text{ M}$$

pH is now calculated:

$$\text{pH} = -\log[1.9 \times 10^{-9}] = 8.72$$

It is seen that the pH at the point of equivalence is somewhat in the basic area. This is always the case for titrations of a weak acid with a strong base.

Case 5: 60.0 mL 0.10 M NaOH solution has been added – solution of a strong base

When further OH^- ions are added after the point of equivalence, these ions will determine the pH. Thus, pH is determined from the excess concentration of OH^- . 50 ml of the NaOH solution was “used” to reach the equivalence point. Thus, 10 ml of the NaOH solution is the excess amount added. The concentration of excess OH^- is determined as:

$$[\text{OH}^-] = \frac{\text{mol OH}^- \text{ ions in excess}}{\text{total volume}} = \frac{10 \text{ mL} \cdot 0.1 \text{ M}}{(0.0500 \text{ L} + 0.0600 \text{ L})} = 9.1 \times 10^{-3} \text{ M}$$

Thus, the concentrations of OH^- is $9.1 \times 10^{-3} \text{ M}$. The concentration of H_3O^+ is again calculated from K_w :

$$[\text{H}_3\text{O}^+] \cdot [\text{OH}^-] = K_w \Rightarrow [\text{H}_3\text{O}^+] = \frac{1.0 \times 10^{-14} \text{ M}^2}{9.1 \times 10^{-3} \text{ M}} = 1.1 \times 10^{-12} \text{ M}$$

pH is now calculated:

$$\text{pH} = -\log[1.1 \times 10^{-12}] = 11.96$$

The pH profile for such a titration is seen in figure 5-2.

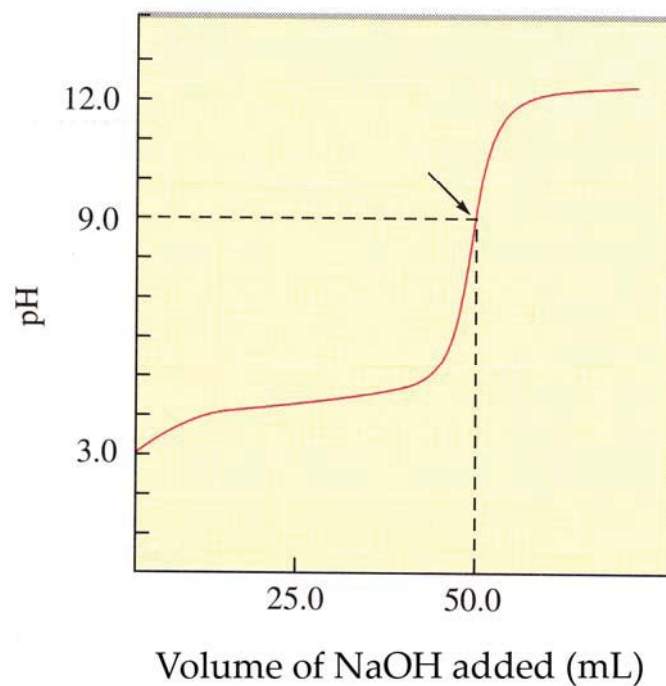

Figure 5- 2: Titration curve

pH profile for a titration of 50.0 mL CH_3COOH with a 0.10 M NaOH solution.

Please click the advert



oxygen.ie

Download 3rd level revision guides for free
– brought to you by oxygen.ie

Download free books at BookBooN.com

5.6.1 Titration of a polyprotic acids

We will now look at a titration of a polyprotic acid:

Example 5- J: Titration of a divalent acid

We look at a general divalent acid, denoted H_2A , with the following two K_a values:

$$K_{a1} = 1.0 \times 10^{-4} \text{ M and } K_{a2} = 1.0 \times 10^{-9} \text{ M} \Rightarrow \\ pK_{a1} = 4.0 \text{ and } pK_{a2} = 9.0$$

We are to titrate 20.0 mL 0.100 M solution of H_2A with a 0.100 M solution of strong base, NaOH, and we wish to determine pH during titration. At the beginning of the titration, we have a 0.100 M solution of the acid H_2A which is a weak acid (seen from the first K_a value). Analogously to earlier calculations:

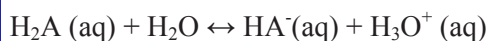

$$K_{a1} = 1.0 \times 10^{-4} \text{ M} = \frac{[H_3O^{\oplus}] \cdot [HA^{\ominus}]}{[H_2A]}$$

The initial concentrations are:

$$[H_2A]_0 = 0.100 \text{ M}$$

$$[HA^{\ominus}]_0 = 0 \text{ M}$$

$$[H_3O^{\oplus}]_0 \approx 0 \text{ M (the autoprotolysis of water is neglected)}$$

The end concentrations are:

$$[H_2A] = (0.100 - x) \text{ M}$$

$$[HA^{\ominus}] = x \text{ M}$$

$$[H_3O^{\oplus}] \approx x \text{ M}$$

The equilibrium expression is:

$$K_{a1} = 1.0 \times 10^{-4} \text{ M} = \frac{[\text{H}_3\text{O}^+][\text{HA}^-]}{[\text{H}_2\text{A}]} = \frac{x \cdot x}{0.100 - x} \Rightarrow x = 3.1 \times 10^{-3} \text{ M}$$

Thus, $[\text{H}_3\text{O}^+] = 3.1 \times 10^{-3} \text{ M}$ and pH is calculated:

$$\text{pH} = -\log[\text{H}_3\text{O}^+] = -\log(3.1 \times 10^{-3}) = 2.51$$

On the way to the first point of equivalence, we have a buffer system consisting of the weak acid H_2A and the corresponding weak base HA^- . Halfway towards the first point of equivalence, pH is calculated from the buffer equation:

$$\text{pH} = \text{p}K_{a1} - \log\left(\frac{[\text{H}_2\text{A}]}{[\text{HA}^-]}\right) = \text{p}K_{a1} = 4.00$$

We again note that half way towards the point of equivalence, the amounts of H_2A and HA^- are equal and pH equals $\text{p}K_a$. The first point of equivalence is reached when the amount of H_2A is equal to the amount of added NaOH; exactly when 20.0 mL of 0.100 M NaOH is added. At that point, we have a solution containing HA^- which may function both as an acid and as a base – this is called an amfolyte, and pH of an amfolyte is determined from the following equation:

$$\text{pH} = \frac{1}{2} \cdot (\text{p}K_a(\text{acid}) + \text{p}K_a(\text{amfolyte})) \quad (5-4)$$

As both K_a values are known, pH is:

$$\text{pH} = \frac{1}{2}(4.0 + 9.0) = 6.50$$

Between the first and the second point of equivalence, we have a buffer system consisting of a weak acid HA^- and its corresponding weak base A^{2-} . Halfway towards the second point of equivalence, pH is calculated from the buffer equation:

$$\text{pH} = \text{p}K_{a2} - \log\left(\frac{[\text{HA}^-]}{[\text{A}^{2-}]}\right) = \text{p}K_{a2} = 9.00$$

The second and last point of equivalence is reached when the amount of NaOH is the double of the initial amount of H_2A ; when 40.0 mL of 0.100 M NaOH is added. All acid is now on the base form A^{2-} and the volume of the solution is increased to 60.0 mL. Now it is a question of determining pH in a solution of the base A^{2-} . The “initial” concentration is:

$$[A^{2-}] = \frac{0.0200L \cdot 0.100\text{mol/L}}{0.0600L} = 3.3 \times 10^{-2} \text{ mol/L}$$

The equilibrium reaction and equilibrium expression:

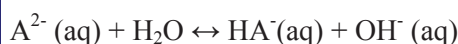

$$K_b(A^{2-}) = \frac{K_w}{K_a(HA^{-})} = \frac{1.0 \times 10^{-14} \text{ M}^2}{1.0 \times 10^{-9} \text{ M}} = 1.0 \times 10^{-5} \text{ M} = \frac{[OH^{-}] \cdot [HA^{-}]}{[A^{2-}]}$$

Once again we look at the initial concentrations

$$[A^{2-}]_0 = 3.3 \times 10^{-2} \text{ M}$$

$$[HA^{-}]_0 = 0 \text{ M}$$

$$[OH^{-}]_0 \approx 0 \text{ M (the autoprotolysis of water is neglected)}$$

and the end concentrations:

$$[A^{2-}] = (3.3 \times 10^{-2} - x) \text{ M}$$

$$[HA^{-}] = x \text{ M}$$

$$[OH^{-}] \approx x \text{ M}$$

The equilibrium expression is:

$$K_b = 1.0 \times 10^{-5} \text{ M} = \frac{x \cdot x}{3.3 \times 10^{-2} - x} \Rightarrow x = 5.7 \times 10^{-4} \text{ M}$$

The concentration of OH^{-} is $5.7 \times 10^{-4} \text{ M}$ and $[H_3O^{+}]$ is calculated from K_w :

$$[H_3O^{+}] \cdot [OH^{-}] = K_w \Rightarrow [H_3O^{+}] = \frac{1.0 \times 10^{-14} \text{ M}^2}{5.7 \times 10^{-4} \text{ M}} = 1.7 \times 10^{-11} \text{ M}$$

Now pH is calculated:

$$\text{pH} = -\log[1.7 \times 10^{-11}] = 10.8$$

After the second point of equivalence, the solution only comprise a solution of the weak base A^{2-} as well as strong base OH^{-} . In this case we will, as earlier, neglect the contribution from A^{2-} to pH, and thereafter calculate pH as in a solution of only strong base.

5.6.2 Colour indicators for acid/base titration

Apart from using a pH meter to determine the pH value in a given solution, a colour indicator is often added to a given solution that is to be titrated. Such a colour indicator changes colour when the point of equivalence is reached. A typical colour indicator is a complex molecule, often being actually a weak acid itself. In general, an indicator may be represented as "HIn". Colour indicators exhibit one colour with the proton and another colour without the proton. A well-known example is phenolphthalein which is opaque in its HIn form, while the colour changes to violet in its In^- form.

A hypothetical colour indicator HIn (which is a weak acid) has a K_a value of 1.0×10^{-8} M. HIn is in equilibrium with In^- :



Please click the advert



DIVERSE - INNOVATIVE - INTERNATIONAL

Are you considering a European business degree?

Copenhagen Business School is one of the largest business schools in Northern Europe with more than 15,000 students from Europe, North America, Australia and Asia.

Are you curious to know how a modern European business school competes with a diverse, innovative and international study environment?

Please visit Copenhagen Business School at www.cbs.dk



Copenhagen Business School
HANDELSHØJSKOLEN

Diversity creating knowledge





The indicator is red in its HIn form while the colour is blue in the In⁻ form. The equilibrium expression is:

$$K_a = \frac{[\text{H}^+][\text{In}^-]}{[\text{HIn}]} \Leftrightarrow \frac{K_a}{[\text{H}^+]} = \frac{[\text{In}^-]}{[\text{HIn}]}$$

Assume that a few drops of indicator is added to a solution with a pH of 2.0. From the expression above, we get the relationship between In⁻ and HIn:

$$\frac{K_a}{[\text{H}^+]} = \frac{1.0 \cdot 10^{-8} \text{ M}}{(10^{-\text{pH}}) \text{ M}} = \frac{1}{1000000}$$

This simple calculation indicates that the dominating form is HIn. Thus, the solution appears red. A relevant question is now how much In⁻ that have to be in the solution in order for the human eye to be able to detect a colour shift. For most indicators it is a rule of thumb that at least one tenth of HIn must change into In⁻ before the human eye is able to detect a change in colour.

5.7 Summing up on chapter 5

In this chapter we have looked at a central part of the aqueous chemistry; the acid/base chemistry. We initially saw how a H⁺ ion is transferred from the acid to the base and how acid strength is defined analogously to the principles of equilibrium. Furthermore, the pH scale was defined and we saw how water molecules are able to react with one another in the process of autoprotolysis. The autoprotolysis of water contributes to the H₃O⁺ and OH⁻ concentration. However, in most cases the autoprotolytic contribution can be neglected when the values of H₃O⁺ and OH⁻ concentrations are larger than ~ 10⁻⁵ M.

Calculations of pH in different types of solutions were exemplified and we saw how polyprotic acids are capable of providing H⁺ ions in several steps. In connection with this, we looked at acid and base properties of salts.

The concept of buffer chemistry was introduced and we saw how pH is calculated in buffer solutions using the buffer equation. When one has a solution of a weak acid and its corresponding weak base, both in the same concentration range, one has a buffer system and the buffer equation can be used to calculate pH. Finally, we looked at titration, titration pH curves, and colour indications used for titration.

6. Electrochemistry

A number of the chemical processes, known from our daily life, can be categorized as electrochemical processes. As the name implies, electrochemistry has to do with the transfer of electrons. We shall be looking at oxidation and reduction.

6.1 Oxidation and reduction

We have, in earlier chapters, been looking at ionic compounds, e.g. sodium chloride:

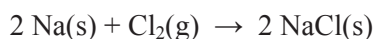

In this reaction, Na(s) and the diatomic Cl₂ molecules react and NaCl is formed (consisting of Na⁺ and Cl⁻ in a lattice). Such a reaction involves transfer of electrons; sodium is oxidized (“loose” an electron) and chlorine is reduced (“adopts” an electron). Such oxidation/reduction reaction is denoted a *redox reaction*. Many important chemical reactions are redox reactions. Oxidation is defined as an increase of the oxidation level while reduction is defined as a decrease in the oxidation level.

Please click the advert



Sharp Minds - Bright Ideas!

Employees at FOSS Analytical A/S are living proof of the company value - First - using new inventions to make dedicated solutions for our customers. With sharp minds and cross functional teamwork, we constantly strive to develop new unique products - Would you like to join our team?

FOSS works diligently with innovation and development as basis for its growth. It is reflected in the fact that more than 200 of the 1200 employees in FOSS work with Research & Development in Scandinavia and USA. Engineers at FOSS work in production, development and marketing, within a wide range of different fields, i.e. Chemistry, Electronics, Mechanics, Software, Optics, Microbiology, Chemometrics.

We offer
A challenging job in an international and innovative company that is leading in its field. You will get the opportunity to work with the most advanced technology together with highly skilled colleagues.

Read more about FOSS at www.foss.dk - or go directly to our student site www.foss.dk/sharpminds where you can learn more about your possibilities of working together with us on projects, your thesis etc.

The Family owned FOSS group is the world leader as supplier of dedicated, high-tech analytical solutions which measure and control the quality and production of agricultural, food, pharmaceutical and chemical products. Main activities are initiated from Denmark, Sweden and USA with headquarters domiciled in Hillerød, DK. The products are marketed globally by 23 sales companies and an extensive net of distributors. In line with the corevalue to be 'First', the company intends to expand its market position.

Dedicated Analytical Solutions

FOSS
 Slangerupgade 69
 3400 Hillerød
 Tel. +45 70103370
www.foss.dk



6.1.1 Level of oxidation

In order to keep track of the number of electrons in a redox reaction, the so-called levels of oxidation are introduced. They are defined from a certain set of rules defining how electrons should be “divided” between the components in covalent bonds. We will look further into these rules below, but first it is necessary to recall the phenomenon of electro negativity. We saw earlier how different atoms have different electro negativity meaning that the different atoms have different abilities to attract electrons from other atoms. This is important in respect to chemical bonds. As previously mentioned, the non-metals in the upper right corner of the periodic table have the highest abilities to attract electrons. Below is shown the order of electro negativity for some non-metals:

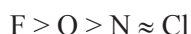

Fluorine has the largest ability to attract electrons followed by oxygen, nitrogen, and chlorine. Such considerations have importance in respect to the rules for oxidation levels, summarised below:

- The oxidation level of a neutrally non-charged atom/molecule is zero. E.g. the oxidation level of $H_2(g)$ and $Na(s)$ are both zero.
- The oxidation level of a mono atomic ion is the same as the charge. Thus, the oxidation level of the Na^+ is +1 while it is -1 for Cl^- .
- In covalent compounds with non-metals, the hydrogen is given the oxidation level of +1. This means that in the following compounds, the oxidation level for hydrogen are all +1: HCl , NH_3 , and H_2O . Thereby the oxidation level is -1 for Cl in HCl , -3 for N in NH_3 , and -2 for O in H_2O .
- Oxygen is given the oxidation level -2 in covalent compounds. E.g. in CO , CO_2 , and SO_3 oxygen has an oxidation level of -2. The only exception from this rule is in peroxide compounds (containing O_2^{2-}) as e.g. H_2O_2 in which each oxygen atoms have an oxidation level of -1.
- Fluorine is always given the oxidation level of -1 while nitrogen typically is given the level of -3 and sulphur typically -2.
- The sum of the oxidation levels must be zero for a non-charged compound. E.g. the sum of oxidation levels for hydrogen and oxygen must equal zero in H_2O while the sum of the oxidation level must equal +1 in a compound like NH_4^+ and -2 in a compound like CO_3^{2-} .

Example 6- A: Assigning levels of oxidation

We are to assign levels of oxidation to all atoms in the following compounds:

CO_2 , H_2SO_4 , NO_3^- , and HF

Oxidation levels in CO_2 :

From the rules, given above, we have that each oxygen atom is assigned the oxidation level of -2. The oxidation level for C may thereby be determined on the basis of this and the fact that CO_2 does not have any external charge. Thus, the sum of oxidation levels must equal zero. Therefore, C in CO_2 has a level of oxidation of +4.

Oxidation levels in H_2SO_4 :

Oxygen atom is given an oxidation level of -2 while the hydrogen atom is given a level of +1. The oxidation level for S may thereby be determined on the basis of this as well as on the basis of the fact that H_2SO_4 does not have an external charge. Thus, the sum of the oxidation levels must equal zero. Hence, S in H_2SO_4 has an oxidation level of +6

Oxidation levels in NO_3^- :

Oxygen atoms are assigned the oxidation level of -2. The oxidation level for N may thereby be determined on the basis of this as well as on the fact that NO_3^- have an external charge of -1. Thus, the sum of the oxidation levels must equal -1 according to the rules. Therefore, N in NO_3^- has an oxidation level of +5.

Levels of oxidations in HF :

According to the rules, each hydrogen atom is assigned the oxidation level of +1. The level of oxidation for F is always -1. Furthermore, the sum of oxidation levels equal zero since the molecule is non-charged.

6.1.2 Methods for balancing redox reactions

One thing is to determine oxidation levels for single compounds. However to be able to use these oxidation levels in practice, it is necessary to balance redox reaction equations. The Redox reactions are often complicated and it is thereby necessary to achieve a certain routine in matching such redox equations. First we will look briefly at the following redox reaction which has to be balanced:

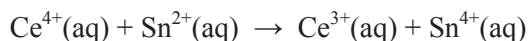

This reaction may be divided into the following half-reactions:

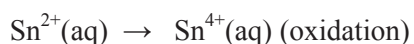
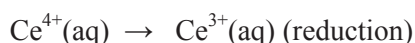

The principle in the work of progress is to balance the two half-reactions separately and add them together in order to achieve the balanced overall reaction. We will look into this in the following example:

Please click the advert

**Design your
own future at
MAN Diesel**

www.mandiesel.com

MAN Diesel – Powering the World



Download free books at BookBooN.com

Example 6- B: The method of half-reaction in acid aqueous solution

We consider the following redox reaction. We wish to balance reaction (in an acid solution):

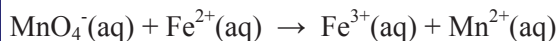

This reaction is often used to analyse the contents of iron in iron ores. The first step is to identify and write down the reaction equations for the half-reaction. First we write the half-reactions for the oxidation reaction. It is clear from the overall reaction that it is the iron ion that is oxidized:

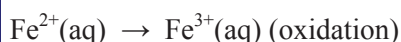

The reductions half-reaction is the following:

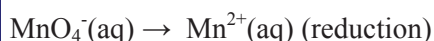

The next step is to balance each of the half-reactions in order to match the charge on each side. The equations are balanced in terms of electrons:



Now the number of electrons matches on each side of the half-reactions (note that oxygen is not balanced yet). In order to make the equations ready for "addition", the oxidation reaction should be multiplied with "5", as the reduction reaction involves 5 electrons while the oxidation only involves 1 electron. We thereby get:

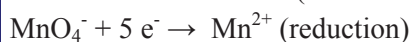
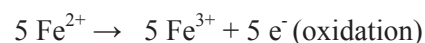

Now the equations are added:

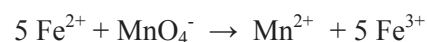

The next step is to balance the reaction in order to match the charges. When we have an acid solution, we balance with H^+ while we balance with OH^- in basic solutions. The charges on both sides of the reaction arrow are calculated:

$$5 \times (+2) + (-1) \rightarrow (+2) + 5 \times (+3) =$$

$$+9 \rightarrow +17$$

We thereby have to add 8 H^+ on the left side in order to make sure that there is the same number of charges of on the left and the right side:



The last step is to balance with H_2O in order to make sure that there is the same number of atoms of both side of the reaction arrow. In this case, it is necessary to place 4 H_2O molecules on the right side:

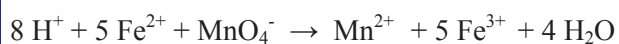

As an extra control, one may check if the charges are the same of both sides of the reaction arrow:

Left side: $8 \times (+1) + 5 \times (+2) + (-1) = +17$

Right side: $(+2) + 5 \times (+3) + 4 \times 0 = +17$

As an extra-extra control, one may make sure that the same number of atoms are on both sides of the reaction:

Left side: 5 Fe, 1 Mn, 4 O, 8 H

Right side: 5 Fe, 1 Mn, 4 O, 8 H

In the next example, we shall balance a redox reaction in a basic solution:

Please click the advert

Student Discounts + **Student Events** + **Money Saving Advice** = **Happy Days!**

wealthystudent.co.uk

Example 6- C: The method of half-reaction in basic aqueous solution

Silver is sometimes found as large lumps mixed with other metals in ores. An easy method to extract the silver is with the use of the cyanide ion CN^- through the following reaction in basic solution:

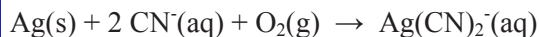

We will balance the reaction equation using the half-reaction principle. The first step is to identify and write the reaction equations for the half-reactions. First we write the half-reactions for the oxidation reaction:



For the reduction reaction, we do not know the product:

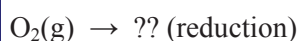

The next step is to balance each of the half-reactions in order to make sure that the number of electrons balance. For the oxidation reaction we have:

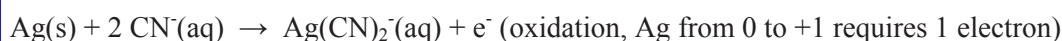

We don't know the product of the reaction but from the general rules stated earlier, we know that oxygen is often in the oxidation level of -2. We thereby assume the product of the reduction reaction is O^{2-} . The balancing with electron thereby becomes:



As the oxidation involves 1 electron and the reduction involves 4 electrons, we multiply the oxidation with 4 and hereby the half-reactions are added:

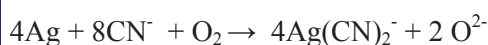

In basic solution we have oxide although not on the O^{2-} form, but rather on the protonised OH^- form giving:

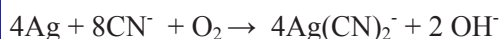

The charges of both sides are calculated and balanced:

$$4 \times (0) + 8 \times (-1) + (0) \rightarrow 4 \times (-1) + 2 \times (-1) = -8 \rightarrow -6$$

As we have a basic solution, we balance with 2 OH⁻ on the right side of the reaction:

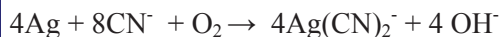

Last step is to balance with water molecules such that the atoms match on both sides of the reaction arrow. In the last case, we balance with 2 H₂O-molecules on the left side:

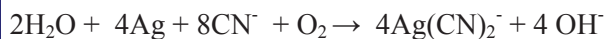

As an extra control one may control that the charges match on both sides of the reaction arrow:

Left side: $8 \times (-1) = -8$

Right side: $4 \times (-1) + 4 \times (-1) = -8$

As an extra-extra control one may make sure that there are equally many of each type of atoms on both sides of the reaction arrow:

Left side: 4 Ag, 8 C, 4 O, 8 N, 4 H

Right side: 4 Ag, 8 C, 4 O, 8 N, 4 H

Please click the advert

Read The Spanner online on oxygen.ie

Download free books at BookBooN.com

6.2 Galvanic cells

We saw in the previous section how redox reactions involve the transfer of electrons and how the oxidation means “loss” of electrons (increase in oxidation level) while the reduction means increase in electrons (decrease in oxidation level). In order to understand how a redox reaction can generate current, we first look at the following reaction between MnO_4^- and Fe^{2+} that was balanced in example 6-B.

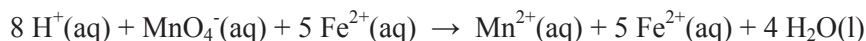

In this reaction, Fe^{2+} is oxidised while MnO_4^- is reduced. Electrons are thereby being transferred from Fe^{2+} to MnO_4^- . We will look further into each of the half-reactions separately. We have the reduction reaction:

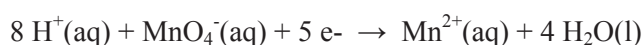

and similarly the oxidation reaction:

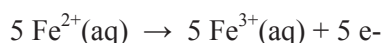

Note how the oxidation reaction must “run” five times each time one reduction reaction takes place. When MnO_4^- and Fe^{2+} are present in the same solution, the electrons are transferred directly when the reactants collide. Under these conditions, no energy is extracted as all the chemical energy is lost as heat. How may we then extract energy from the reaction? The answer is to separate the oxidation reaction from the reduction reaction; this requires a wire (e.g. copper or silver wire). The current that flows between the two solutions may be let through e.g. an electrical bulb or through an electrical motor. Thereby we have extracted energy from a chemical reaction. This concept requires that a salt bridge and a wire is established in the system in order to allow transport of ions without completely mixing the solutions. The principle is sketched in figure 6-1.

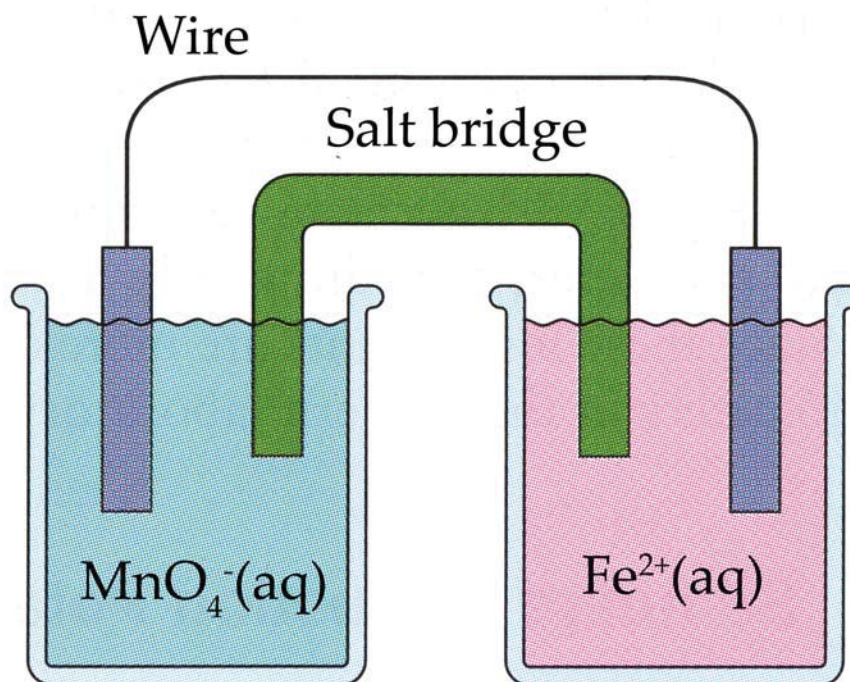

Figure 6- 1: The principle of a galvanic cell
Schematic set-up of the separation of oxidation- and reduction-reactions (a redox reaction) between Fe^{2+} and MnO_4^-

We have described the principal parts of a galvanic element (also known as the galvanic cell) which is a set-up in which chemical energy is converted into electrical energy. The reaction in an electrochemical cell takes place in the boundary layer between the electrode (the part that is dipped into the solution) and the solution itself. The electrode at which the oxidation reaction takes place is called the anode while the electrode at which the reduction takes place is called the cathode.

6.2.2 Cell potentials

A galvanic cell, as we have seen, consists of an oxidation component that “delivers” electrons through a wire to a reduction component in another solution. The driving force causing the electron transfer is called the cell potential or the electromotoric force (in short EMF), measured in is volt, V, e.g. energy pr. charge (joule pr. coulomb). The electromotoric force is defined as:

$$\text{EMF} = \text{cell potential} = \frac{\text{work (J)}}{\text{charge (C)}} \quad (6-1)$$

In order for a cell reaction to take place spontaneously, it is necessary that the cell potential is positive.

6.3 Standard reduction potentials

The reaction in a galvanic cell is always a redox reaction that can be divided into two half-cell reactions. As well as the whole cell has a cell potential, a half-cell potential is associated with the half-cell reaction. The cell potential for the entire cell is thus the sum of the two half-cell potentials:

Please click the advert

WHAT'S MISSING IN THIS EQUATION?

You could be one of our future talents

MAERSK INTERNATIONAL TECHNOLOGY & SCIENCE PROGRAMME

Are you about to graduate as an **engineer** or **geoscientist**? Or have you already graduated?
If so, there may be an exciting future for you with A.P. Moller - Maersk.



MAERSK

www.maersk.com/mitas

Example 6- D: Half-cell potentials

A galvanic cell contains a solution of ZnSO_4 connected through a porous wall (similar to the salt bridge presented earlier) with a solution of HCl . Into the zinc sulphate solution, a rod of zinc metal is submerged connected to a platinum electrode placed into the hydrochloric acid solution. Simultaneously, H_2 in gas form is lead through the platinum electrode. Between the platinum and zinc electrode, voltmeter is placed. The figure below presents the set-up of a galvanic cell.

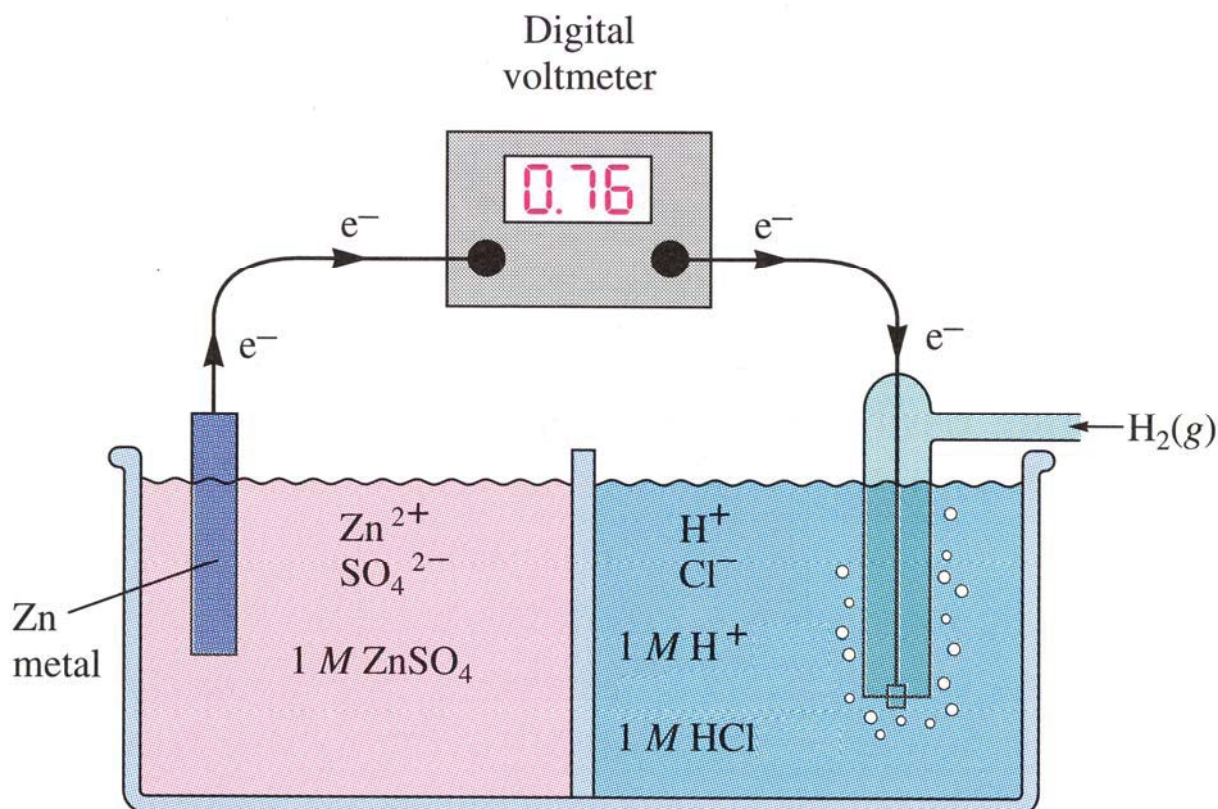
**Figure 6- 2: Galvanic cell**

Schematic setup of a galvanic cell consisting of a zinc electrode/ ZnSO_4 solution and a platinum electrode/ HCl solution.

As it may be seen from the figure above, the cell potential for the entire cell is observed to be 0.76 volt corresponding to the overall cell reaction:

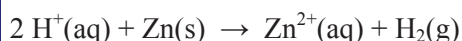

For the given galvanic cell, the anode part contains a zinc metal electrode with Zn^{2+} and SO_4^{2-} ions in an aqueous solution surrounding the electrode. The anode reaction is:

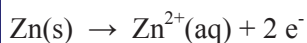

From the anode reaction, each zinc atom loses two electrons and migrate into the solution as Zn^{2+} ions. The two electrons pass through the wire to the cathode solution where the following reaction takes place:

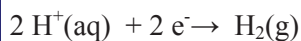

The cathode consists of platinum which is an inert conductor in contact with the 1 M H^+ ions surrounded by hydrogen gas at 1 atm. Such an electrode is called a *standard hydrogen electrode* which by definition has a half-cell potential (at 298 K) $\mathcal{E}^0 = 0.00$ volt. The figure below shows the principle in the build up of a standard hydrogen electrode.

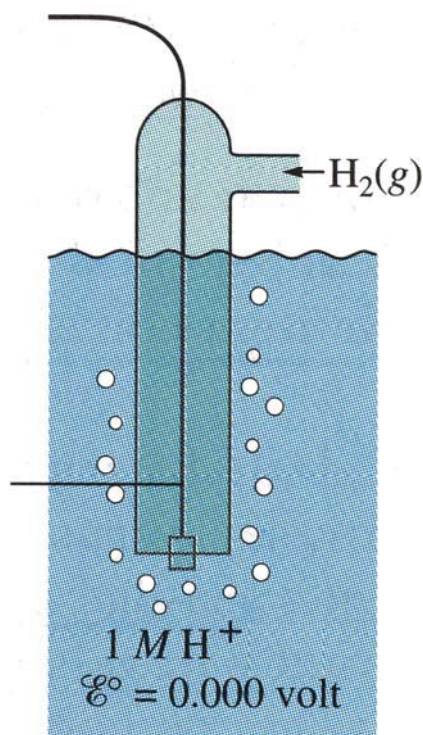
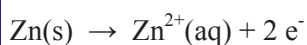

Figure 6- 3: The standard hydrogen electrode

The standard hydrogen electrode by definition has a half-cell potential of 0.0 Volt at a H^+ concentration of 1,0 M at 298 K.

Even though we are capable of measure the galvanic cell potential in terms of the voltmeter placed between the two electrodes, it is not possible to measure the two half-cell potentials separately. We thereby have to define a half-cell reaction from which we may determine other half-cell potentials. As mentioned above, it has been chosen to let the half-cell potential for the standard hydrogen electrode equal zero. Thus, it is possible to determine all other half-cell potentials from this. In the present case we may therefore say that the half-cell reaction



has a half-cell potential of 0.76 volt since this is the value of the voltmeter when combined with the standard hydrogen half-cell reaction.

In order to determine overall cell potentials from half-cell potentials, the following Gibb's equation is used:

$$\Delta G^0 = -z \cdot F \cdot \varepsilon^0 \quad (6-2)$$

ΔG^0 denotes the change in standard Gibb's energy while z denotes the number of transferred electrons for the half-cell reaction. The Faraday constant is denoted F . ΔG is often used to determine whether or not a reaction runs spontaneously. The total value of ΔG for an electrochemical reaction is determined as the sum of ΔG 's from the two half-cell reactions. If ΔG is less than zero, the reaction runs spontaneously. If ΔG is larger than zero, energy must be added to the system in order to let the reaction occur.

www.job.oticon.dk

oticon
PEOPLE FIRST

Example 6- E: Calculation of cell potential and spontaneity

A galvanic cell consists of the following two half-cell reactions:

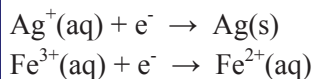

From a table of half-cell potentials we have the following reduction potentials:

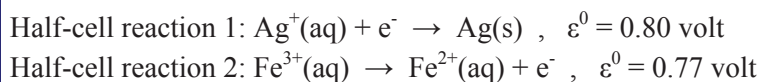

We wish to determine which of the following two reactions that runs spontaneously and what the standard cell potential is:

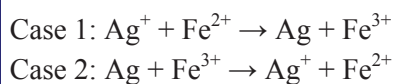

In order to answer this question, ΔG^0 for the two half-cell reactions must be determined using equation (6-2):

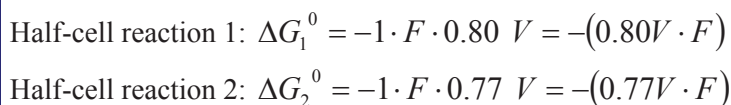

Now ΔG^0 for the two cases can be determined:

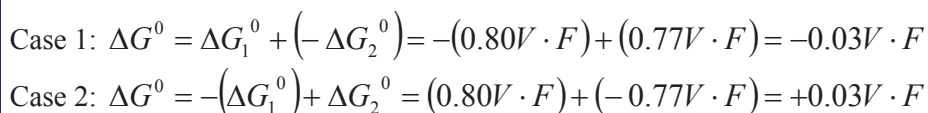

A spontaneous reaction runs only when ΔG^0 is less than 0, case 1 is the reaction that runs in the galvanic cell. The standard potential of the cell is calculated from ΔG^0 (equation (6-2)):

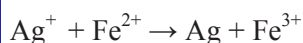

$$\Delta G^0 = -z \cdot F \cdot \varepsilon^0 \Leftrightarrow \varepsilon^0 = \frac{-\Delta G^0}{z \cdot F} = \frac{-(-0.03 \text{ V} \cdot F)}{1 \cdot F} = 0.03 \text{ V}$$

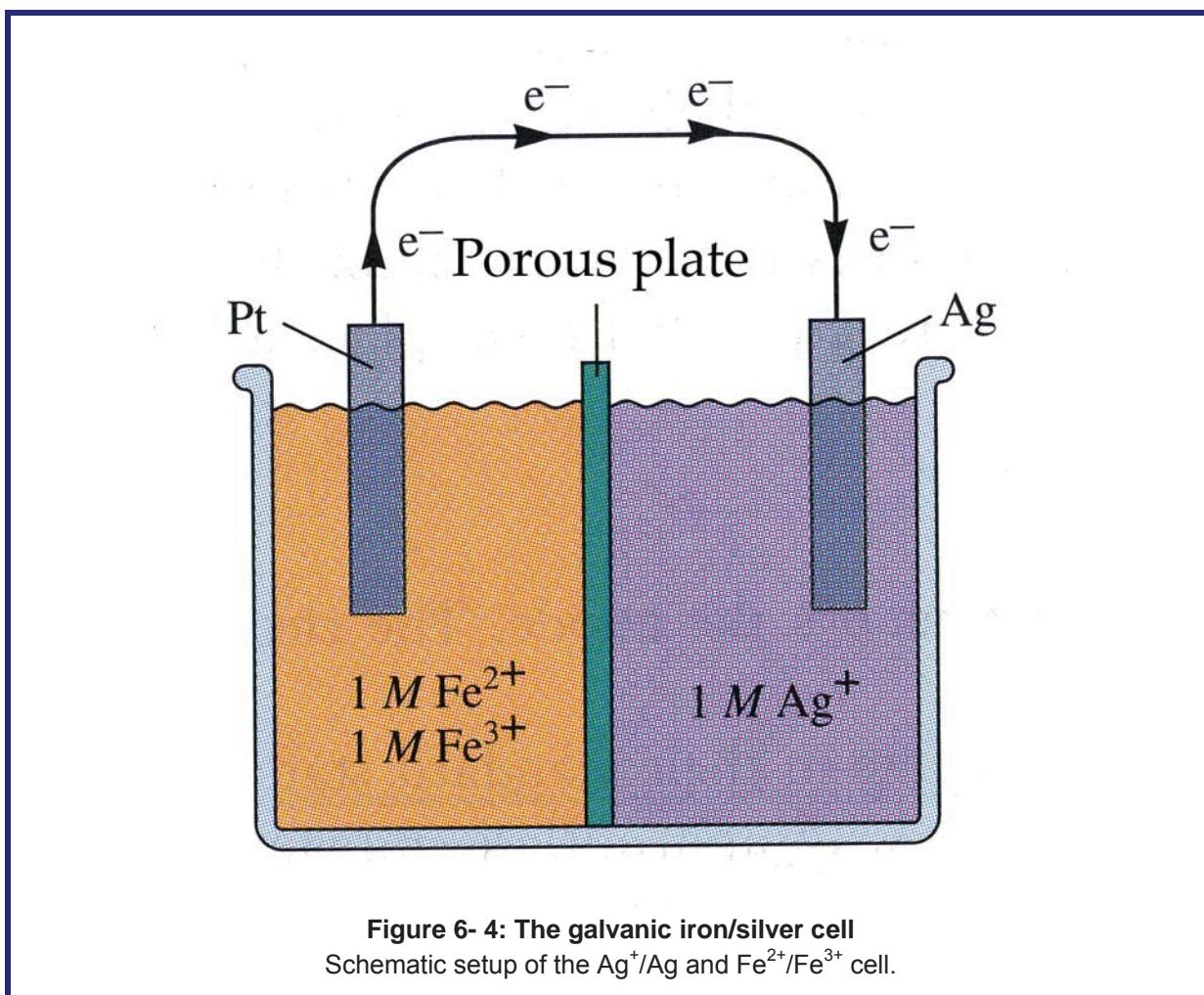

6.4 Concentration dependency of cell potentials

So far we have only looked at galvanic cells under standard conditions. Nevertheless, cell potentials depend on the concentration of the ions that are in the half-cells. E.g. the following overall cell reaction

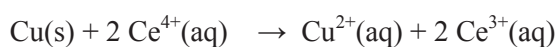

has a cell potential of 1.36 V at 298 K when all ions are in 1 M concentrations. If the conditions are different, the potential of the cell may be different. If the concentration of Ce^{4+} e.g. is larger than 1 M, the reaction, according to the principles of Le Chateliers, will increase to the right and thereby increase the driving force of the cell. The cell potential will thereby increase. The dependence of concentration for the cell potential at 298 K is given by the Nernst equation (named after the German chemist Hermann Nernst):

$$\mathcal{E}_{\text{celle}} = \mathcal{E}_{\text{celle}}^0(\text{Standard conditions}) - \frac{0.0592}{z} \log Y \quad (6-3)$$

Y is the reaction fraction from the overall reaction equation and z is the number of transferred electrons in the overall reaction. We will look further into the application of the Nernst equation in the following example:

Please click the advert



CHALLENGE YOURSELF

WWW.STUDYINSWEDEN.SE

Today's job market values ambitious, innovative, perceptive team players. Swedish universities foster these qualities through a forward-thinking culture where you're close to the latest ideas and global trends.

Whatever your career goals may be, studying in Sweden will give you valuable skills and a competitive advantage for your future. www.studyinsweden.se

Si.
Swedish Institute

Download free books at BookBooN.com

Example 6- F: The use of the Nernst equation to determine the cell potential

A galvanic cell has to following two half-cell reactions:

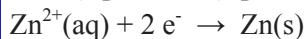
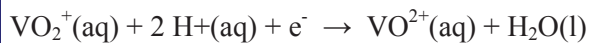

$T = 298 \text{ K}$, $[\text{VO}_2^+] = 2.0 \text{ M}$, $[\text{VO}^{2+}] = 1.0 \times 10^{-2} \text{ M}$, $[\text{H}^+] = 0.50 \text{ M}$, $[\text{Zn}^{2+}] = 1.0 \times 10^{-1} \text{ M}$ and we wish to determine the potential of the cell. As it may be seen, we do not have standard conditions in the cell.

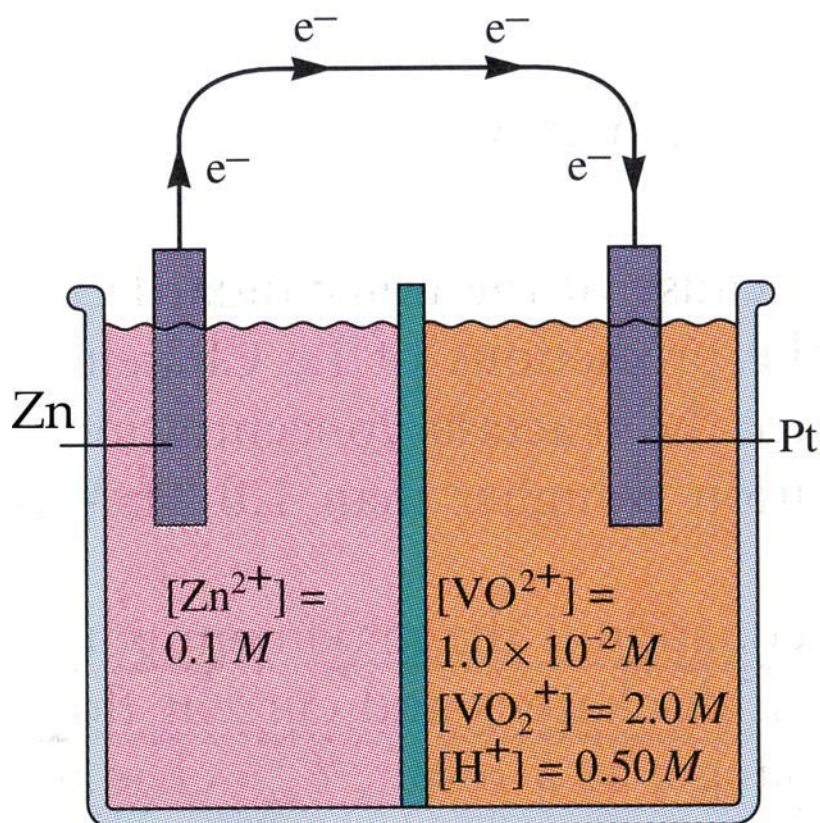
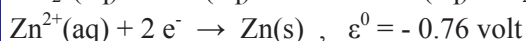
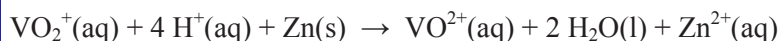

Figure 6- 5: Zinc/vanadium galvanic cell
Schematic setup of the Zn^{2+}/Zn and $\text{VO}^{2+}/\text{VO}_2^+$ cell.

From a Wikipedia we have the following reduction potentials:



As earlier mentioned, there has to be a reducing as well as an oxidising reaction and as the overall potential of the cell has to be positive the overall reaction must be:



The total potential of the cell may be found as:

$$\varepsilon^0(\text{cell}) = 1.00 \text{ V} + (-0.76 \text{ V}) = 1.76 \text{ V}$$

This is the value that we expect to measure if a voltmeter between the two electrodes in the galvanic cell under standard conditions in the half-cells. However, in the present case we do not have standard conditions as the concentrations are different from 1 M. We will thereby use the Nernst equation:

$$\varepsilon_{\text{cell}} = \varepsilon^0_{\text{cell}} - \frac{0.0592}{z} \log Y$$

In this case, $z = 2$ since two electrons are transferred. Y is given as:

$$Y = \frac{[\text{Zn}^{2+}] \cdot [\text{VO}^{2+}]^2}{[\text{VO}_2^+]^2 \cdot [\text{H}^+]^4} = \frac{[1.0 \cdot 10^{-1}] \cdot [1.0 \cdot 10^{-2}]^2}{[2.0]^2 \cdot [0.50]^4} = 4.0 \times 10^{-5}$$

The cell potential is then calculated:

$$\begin{aligned} \varepsilon_{\text{cell}} &= \varepsilon^0_{\text{cell}} - \frac{0.0592}{z} \log Y \Rightarrow \\ \varepsilon_{\text{cell}} &= 1.76 \text{ V} - \frac{0.0592}{2} \log 4.0 \times 10^{-5} = 1.89 \text{ V} \end{aligned}$$

The Nernst equation may also be used to calculate equilibrium constants. We will look into this in the following example:

Example 6- G: The use of the Nernst equation to calculate equilibrium constants

We have a galvanic cell consisting of the following two half-cell reactions:

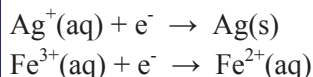

We wish to determine the equilibrium constant K for the overall cell reaction. At equilibrium, the reaction fraction for the cell reaction Y is equal to the equilibrium constant for the cell reaction. Thus, the Nernst equation can be used to determine the value of K . At equilibrium in a galvanic cell, no transfer of electrons takes place between the two half-cell. Thus, $\epsilon_{\text{cell}}^0 = 0$. From Wikipedia we have the following reduction potentials:

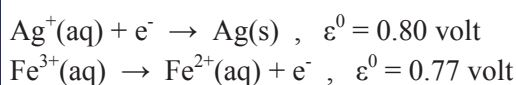

As mentioned earlier, it is necessary that the potential of the cell is positive (meaning that ΔG is negative according to equation (6-2)). In order for the cell reaction to be able to proceed, the reaction between iron(II) and iron(III) has to run backwards. The overall cell reaction (which was also shown in example 6-E) is:

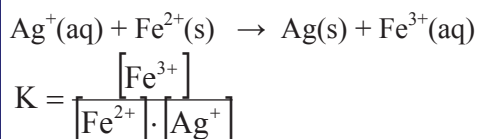

The total standard potential of the cell is determined as:

$$\epsilon^0(\text{cell}) = 0.80 \text{ V} + (-0.77 \text{ V}) = 0.03 \text{ V}$$

From the Nernst equation, the equilibrium constant can be determined:

$$\epsilon_{\text{cell}} = \epsilon_{\text{cell}}^0 - \frac{0.0592}{z} \log Y \Leftrightarrow (\text{at equilibrium}) 0 = \epsilon_{\text{cell}}^0 - \frac{0.0592}{z} \log K \Leftrightarrow$$

$$\log K = \frac{z \cdot \epsilon_{\text{cell}}^0}{0.0592} = \frac{1 \cdot 0.03 \text{ V}}{0.0592} \Rightarrow K = 3.2 \text{ M}$$

As the equilibrium constant is 3.2 M, the equilibrium must be shifted to the right under the given conditions.

6.5 Batteries

One of the well-known applications of electrochemistry is the use of galvanic cells in batteries. A battery is in principle a group of galvanic cells in series, in which the potential of each cell is summed up to give a higher voltage across the battery. Batteries are used for a variety of purposes in our daily life. In the following examples we will look at three types of batteries.

Please click the advert

Always aiming for higher ground. Just another day at the office for a Tiger.

Join the Accenture High Performance Business Forum

On Thursday, April 23rd, Accenture invites top students to the High Performance Business Forum where you can learn how leading Danish companies are using the current economic downturn to gain competitive advantages. You will meet two of Accenture's global senior executives as they present new original research and illustrate how technology can help forward thinking companies cope with the downturn.

Visit student.accentureforum.dk to see the program and register

Visit student.accentureforum.dk

• Consulting • Technology • Outsourcing

accenture
High performance. Delivered.

© 2009 Accenture. All rights reserved.

Example 6- H: Lead battery

The lead battery is used in cars where they deliver current to the start engine. The reason for this widespread use through many years is that lead batteries work well with good performance at typical outdoor temperatures. The anode in the lead battery is a lead electrode while the cathode typically consists of a lead electrode covered with lead oxide. Both electrodes are placed in an electrolytic solution of sulphuric acid. The following half-cell reaction takes place at the anode



while the following half-cell reaction takes place at the cathode:

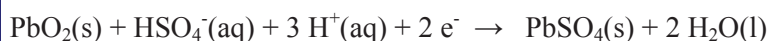

Hereby the overall cell reaction is:



A typical lead battery in a car has six cells in series. As each cell yields 2 volt, the total voltage is 12 volt. Sulphuric acid is used in the reaction, and the battery is hereby slowly discharged. Thus, the density of the electrolytic solution changes and a way to determine the condition of a lead battery is to measure the density of the electrolytic solution.

The lead battery is recharged by passing a current of electrons in the opposite direction of the cell reaction. This happens continuously while the car is driving as the energy for the recharge is generated by the combustion reaction in the engine of the car. The figure below shows the principle in a lead battery.

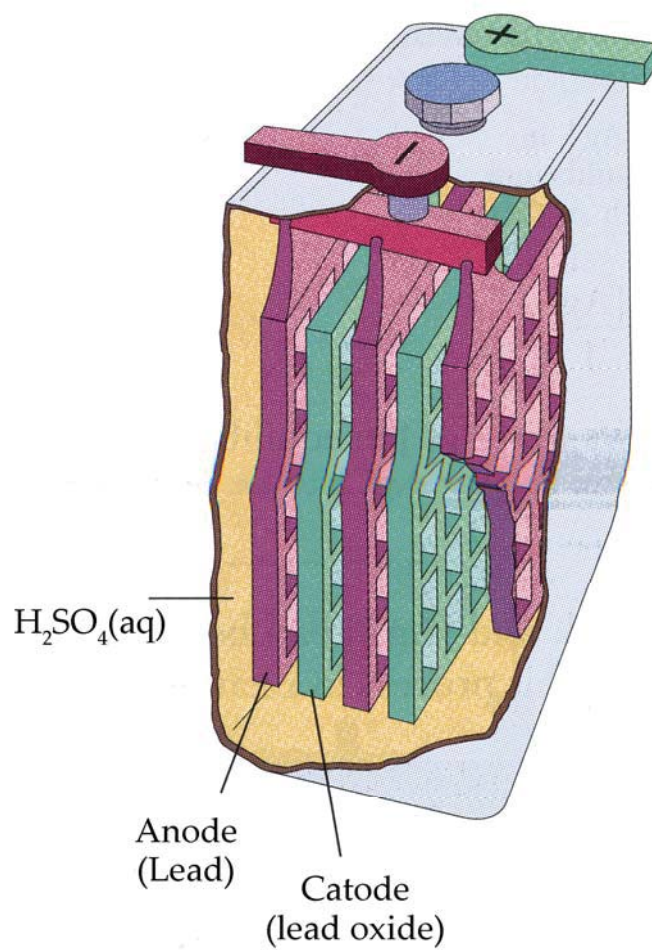
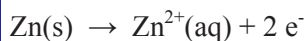

Figure 6- 6: The lead battery
The set-up in a lead battery.

Example 6- I: Dry cell batteries

For the use in watches and pocket calculators, small galvanic cells are used. There are numerous different types of dry cell batteries. In an acid dry cell battery, the inner shell is made of zinc (anode) and a carbon rod in the centre of the cell is in contact with solid MnO_2 and solid NH_4Cl (cathode). The following half-cell reaction takes place at the anode:



The following half-cell reaction takes place at the cathode:

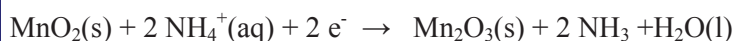

Such a galvanic cell produces roughly 1.5 volt. Thus, it is necessary to insert several dry cell batteries in series to achieve sufficient voltage to run a pocket calculator. The figure below shows the principle of an acid dry cell battery.

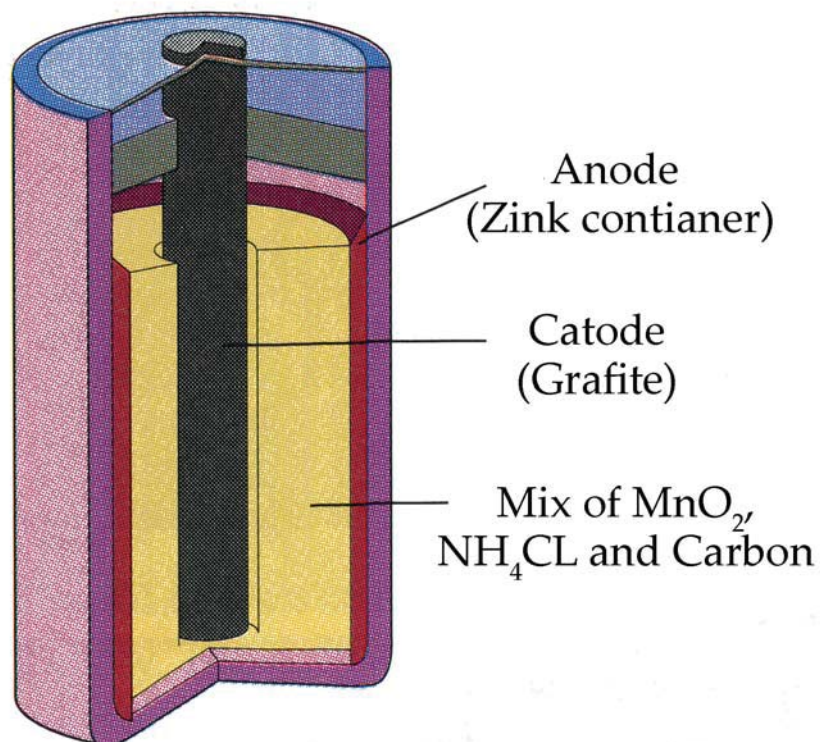
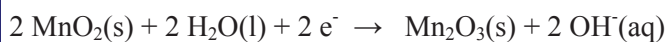

Figure 6- 7: The dry cell battery
Set-up of the acid dry cell battery.

A more modern version of the dry cell battery is the *alkaline* version in which the solid NH_4Cl is replaced by KOH and NaOH . Hereby the following half-cell reaction takes place at the anode:



while the following half-cell reaction takes place at the cathode:



Compared to the acid dry cell battery, the life time of an alkaline battery is significantly longer as zinc corrodes slower in basic surroundings than in an acid environment.

Another type of battery is the mercury battery often used in pocket calculators earlier on. The mercury battery has a zinc electrode while mercury oxide HgO is oxidised in basic environment consisting of typically KOH and Zn(OH)₂. The figure below shows the set-up of the mercury dry cell battery.

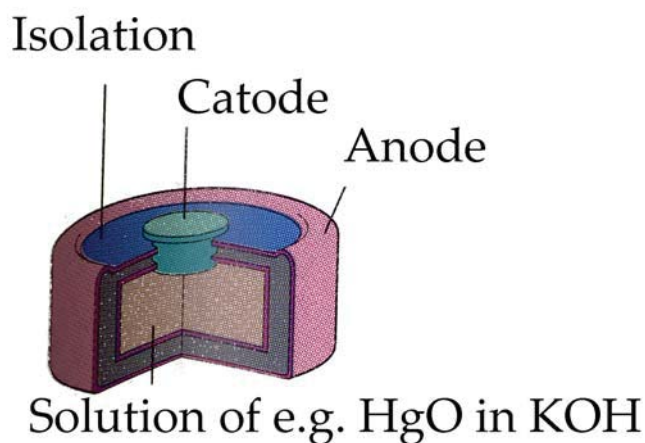

Figure 6- 8: Mercury battery
Sketch of a basic mercury dry cell battery.

Example 6- J: Fuel cells

A fuel cell is in principle a galvanic cell in which the reactants are added continuously to the system. In order to illustrate the principle in a fuel cell reaction, we will look at the exothermal reaction between methane and oxygen which is a redox reaction:



The energy that is formed by the process is normally used to heat up houses or to run engines. In a fuel cell, the energy is extracted as electrical energy directly, as the transferred electrons are “extracted” directly. Similarly, the following reaction

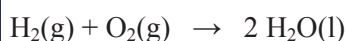

Please click the advert

it's an **interesting** world**Get under the skin of it.**

Graduate opportunities
Cheltenham | £24,945 + benefits

One of the UK's intelligence services, GCHQ's role is two-fold: to gather and analyse intelligence which helps shape Britain's response to global events, and, to provide technical advice for the protection of Government communication and information systems. In doing so, our specialists – in IT, internet, engineering, languages, information assurance, mathematics and intelligence – get well beneath the surface of global affairs. If you thought the world was an interesting place, you really ought to explore our world of work.

www.careersinbritishintelligence.co.uk

Applicants must be British citizens. GCHQ values diversity and welcomes applicants from all sections of the community. We want our workforce to reflect the diversity of our work.



may be used to extract current through a fuel cell which is sketched below:

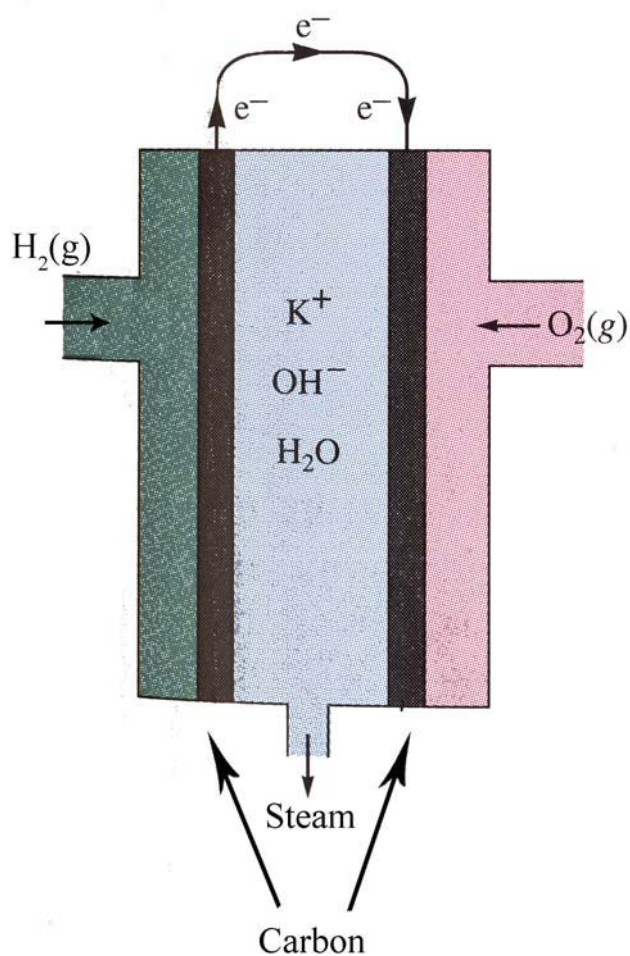
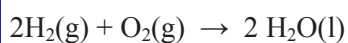

Figure 6- 9: Fuel cell

Sketch of the principle set-up in a fuel cell.

The following half-cell reaction takes place at the anode:



whereas the following half-cell reaction takes place at the cathode:

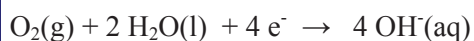

In recent years, the research in fuel cells has increased significantly. One of the reasons for this is that the reactions in fuel cells do not involve environmentally dangerous species. What is of further importance is that fuel cells involve reactions where CO_2 is not produced.

6.6 Corrosion

Well-known phenomenon of corrosion of e.g. copper roofs is closely related to electrochemistry. Because corroded metal, as e.g. iron, loses its strength, corrosion chemistry is of great practical importance. Metals are especially exposed to corrosion as metals are easily oxidised. From tables of standard reduction potentials, one will see that with the exception of noble metals as e.g. gold and silver, the standard reduction potentials of common metals are lower than for oxygen. This means that the oxidation of most metals is a spontaneous reaction. However, even though many metals ought to be corrosive in the presence of oxygen, it is actually seldom the case. This is caused by the fact that many metals build a thin oxide layer on the outside of the metal surface that help to prevent further corrosion.

Example 6- K: Aluminium oxide as protection against corrosion

With a standard reduction potential of -1.7 volt, aluminium ought to corrode relatively easy when being exposed to water and oxygen. Nevertheless, a thin layer of aluminium oxide Al_2O_3 is formed by contact with oxygen as sketched in the figure below:

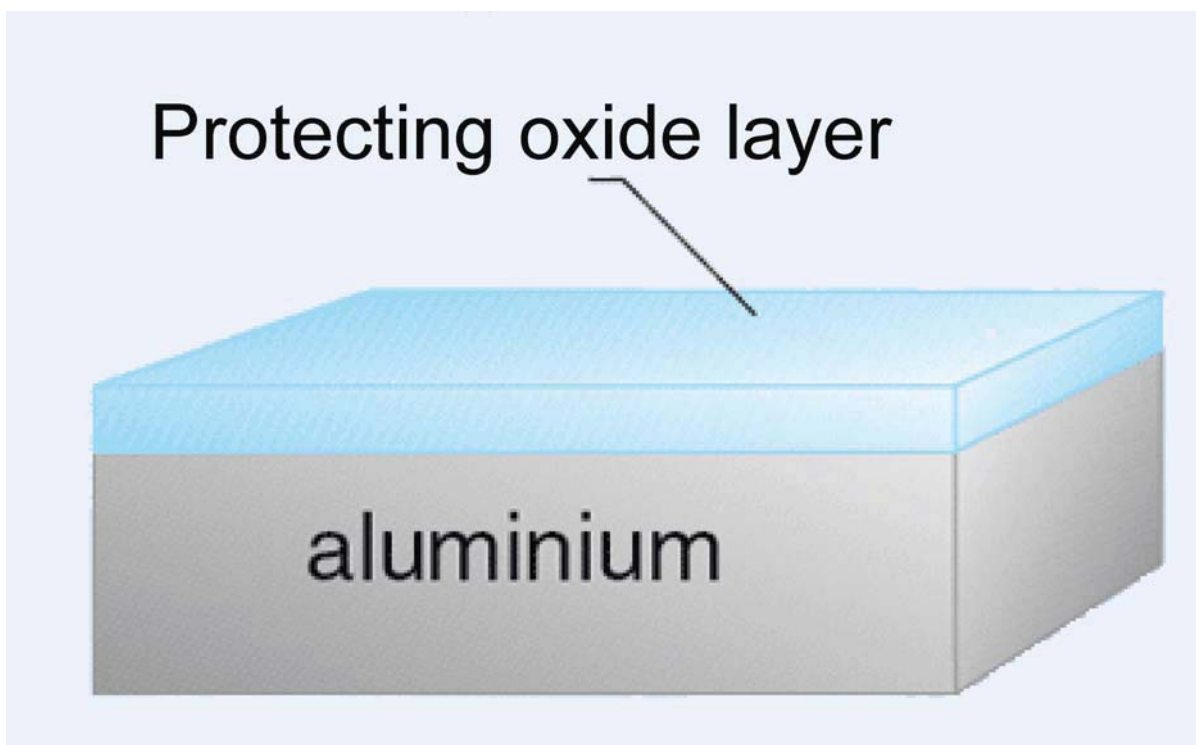

Figure 6- 10: Protecting oxide layer
Formation of aluminium oxide on aluminium metal.

Whereas the oxidation of aluminium metal has a standard reduction potential of -1.7 volt, the oxidation of Al_2O_3 has only a standard reduction potential of -0.6 volt making aluminium oxide almost as corrosion resistant as gold.

Iron forms also an oxide layer (better known as rust) on the surface, but on the contrary to aluminium oxide, the layer does not have the same adhesion and thereby peels off. Hereby “new” iron metal is exposed to oxygen and water and the corrosion process continues.

Example 6- L: Iron rust

Iron or steel is widely used as building material for houses, bridges, cars, etc. Therefore, corrosion of iron is a phenomenon of great importance. Steel is a mixed product in which the main part is iron atoms plus other metals and carbon. The following reaction may occur on steel surfaces:



The electrons from this process are transported to the cathodic regions of the steel. In such cathodic regions on the steel, Fe^{2+} ions react with the oxygen in the air and forms rust which is chemically hydrated iron (III) oxide of variable composition. The reaction may simplified be written as:

Please click the advert

CHALLENGE YOURSELF

WWW.STUDYINSWEDEN.SE

Si.
Swedish Institute

Today's job market values ambitious, innovative, perceptive team players. Swedish universities foster these qualities through a forward-thinking culture where you're close to the latest ideas and global trends.

Whatever your career goals may be, studying in Sweden will give you valuable skills and a competitive advantage for your future. www.studyinsweden.se



Due to the transport of electrons from the anodic regions to the cathodic regions on the steel surface, the rust will often form a distance apart from the site where the iron atoms are oxidised. This is sketched in the figure below:

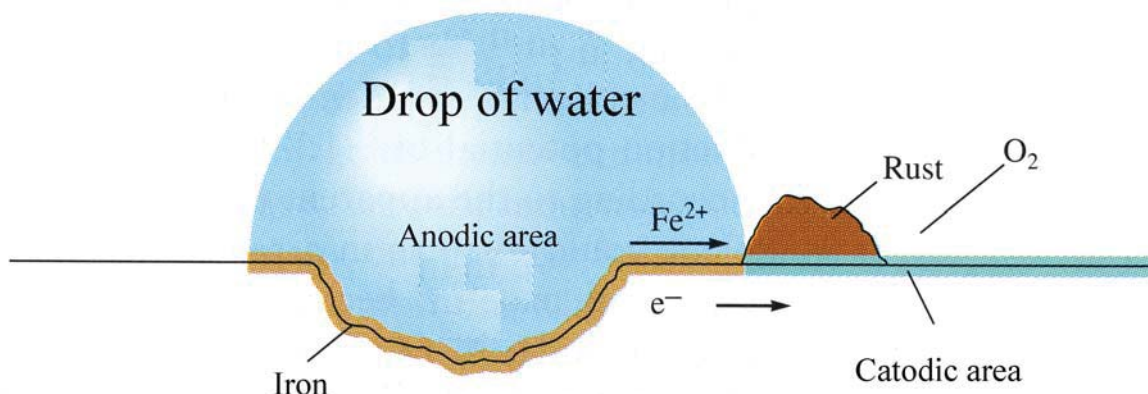
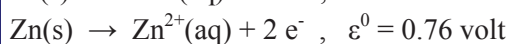
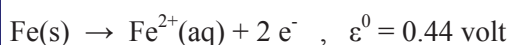

Figure 6- 11: Corrosion of Iron in aqueous environment

The electrochemical corrosion of a steel surface in the presence of water.

What can be done in order to increase the life time for a steel surface? One of the possibilities is to paint the steel surface in order to hinder oxygen and water molecules from getting into contact with the iron atoms. Another possibility is to treat the steel with a more corrosion preventive metal. E.g. is it common to treat the steel with zinc in a so-called galvanisation process closely related to *electrolysis*, which is the subject of the following section. The advantage of coating steel with zinc is that zinc does not form an oxide layer.

Zinc is easier to oxidised than iron which can be seen by the comparison of the reactions below:



This means that zinc will “sacrifice” itself for the sake of iron, meaning that the zinc atoms will be oxidised prior to the iron atoms thereby expanding the life time of the steel.

By applying current to the electrolytic cell, one forces the non-spontaneous reaction to proceed. This principle is widely used to protect metal surfaces from corrosion. The electrolysis reaction may also be used for other purposes:

Example 6- M: Electrolysis of water

We have seen earlier how hydrogen and oxygen may be combined and spontaneously form water molecules and that this reaction produces energy which may be used in fuel cells. The opposite reaction is not spontaneous but requires an electrolytic process to proceed. The following half-cell reaction takes place at the anode:

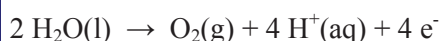

The half-cell potential ϵ^0 is 1.23 volt while that following half-cell reaction takes place at the cathode

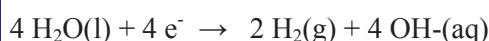

having a half-cell potential of $\epsilon^0 = -0.83$ volt. Hereby the overall cell reaction is:



The cell potential is $\epsilon^0 = -2.06$ volt at standard conditions.

6.8 Summing up on chapter 6

We have looked into several important parts of the electrochemistry in this chapter. We started by looking at the basic principles of oxidation and reduction reactions and introduced the oxidation levels which were used to balance redox reactions.

Furthermore, we looked at galvanic cells in which it was possible to extract electrical energy. We looked into cell potentials and standard reduction potentials. We also looked at concentration dependence of cell potentials and introduced the Nernst-equation stating the combination of the reaction fraction and cell potentials. The use of the Nernst equation was presented through examples in which we saw how the equation could be used to determine equilibrium constants.

In order to highlight the application of electrochemistry in practice, we went through three types of batteries; the lead battery, the dry cell battery, and the fuel cell. We further looked at corrosion and saw how steel may be protected from corrosion in terms of electrochemical treatment with a sacrificing metal such as zinc. Lastly, we looked at electrolysis of metal ion solutions and the electrochemical fractioning of water molecules.